

1-1-2014

# Development Of Active Packaging With Antimicrobial Activity

Xiuxiu Sun  
*Wayne State University,*

Follow this and additional works at: [http://digitalcommons.wayne.edu/oa\\_dissertations](http://digitalcommons.wayne.edu/oa_dissertations)

---

## Recommended Citation

Sun, Xiuxiu, "Development Of Active Packaging With Antimicrobial Activity" (2014). *Wayne State University Dissertations*. Paper 976.

This Open Access Dissertation is brought to you for free and open access by DigitalCommons@WayneState. It has been accepted for inclusion in Wayne State University Dissertations by an authorized administrator of DigitalCommons@WayneState.

**DEVELOPMENT OF ACTIVE PACKAGING WITH ANTIMICROBIAL ACTIVITY**

by

**XIUXIU SUN**

**DISSERTATION**

Submitted to the Graduate School

of Wayne State University,

Detroit, Michigan

in partial fulfillment of the requirements

for the degree of

**DOCTOR OF PHILOSOPHY**

2014

MAJOR: NUTRITION AND FOOD SCIENCE

Approved by:

\_\_\_\_\_  
Advisor

\_\_\_\_\_  
Date

\_\_\_\_\_  
\_\_\_\_\_  
\_\_\_\_\_

© COPYRIGHT BY

Xiuxiu Sun

2014

All Rights Reserved

## DEDICATION

This manuscript is dedicated in loving admiration to my father Denghua Sun, mother Qiaoyun Song, sister Yuanyuan Sun, and brother Gongrui Sun, whose solid support and continued encouragement gave me the foundation and strength to pursue my research.

## ACKNOWLEDGEMENTS

I would like to express my deep gratitude to all the people who helped me to complete this dissertation. First of all, I would like to express my sincere gratitude to my advisor Dr. Kequan Zhou for providing me this golden opportunity. His thoughtful advice and guidance helped me grow professionally. I could not have come this far toward my doctoral degree without his support, encouragement and tolerance. I would also like to thank the scientists Dr. Jinhe Bai and Dr. Jan Narciso, for their guidance and advice throughout my research program.

I would like to express my sincere appreciation to all my committee members, Dr. Ahmad Heydari, Dr. Yifan Zhang and Dr. Jianjun Wang, for their invaluable assistance, guidance and constant encouragement. They are always offering their intellectual opinions and the necessary constructive criticisms. The project would not have finished smoothly without their suggestions and corrections.

I am equally indebted to Shi Sun, Hoda Kadouh, Corene Canning, Wenjun Zhu, Ninghui Zhou and Chia-Chung Chiang for their skillful technical assistance and helpful advice. I am thankful to my friends, Xiangming Ji, Zhe Wang, Shalin Qin, Lixin Wang, Yong Wang, Yudi Wei, Yu-Lyu Yeh *et. al.*, who have shared these years with me. I would also address my thanks to Dr. Liz Baldwin, Dr. Anne Plotto, Dr. Kai-Lin Catherine Jen, Dr. Diane Cabelof and all the other professionals for helping with my doctoral work.

Last, I would like to thank my family and friends, especially my husband Christopher Ference who gave me invaluable help. His love and understanding provided incentive and motivation to make my dream come true.

## TABLE OF CONTENTS

Dedication.....	ii
Acknowledgements .....	iii
List of Tables.....	vi
List of Figures.....	vii
<b>CHAPTER 1 INTRODUCTION .....</b>	<b>1</b>
Active Packaging .....	1
Edible Films and Coatings .....	2
Sachets and Pads.....	5
<b>CHAPTER 2 BACKGROUND AND SPECIFIC AIMS.....</b>	<b>10</b>
Background .....	10
Specific Aim 1 .....	10
Specific Aim 2.....	11
Specific Aim 3.....	12
<b>CHAPTER 3 THE ANTIMICROBIAL, MECHANICAL, PHYSICAL AND     STRUCTURAL PROPERTIES OF CHITOSAN-GALLIC ACID FILMS... </b>	<b>13</b>
Abstract .....	14
Introduction.....	15
Materials and Methods .....	17
Results and Discussion .....	22
Conclusion.....	29
<b>CHAPTER 4 EFFECTS OF CHITOSAN-ESSENTIAL OIL COATINGS ON SAFETY     AND QUALITY OF FRESH BLUEBERRIES.....</b>	<b>36</b>
Abstract .....	37
Introduction.....	38

Materials and Methods .....	41
Results and Discussion .....	45
Conclusion.....	51
<b>CHAPTER 5 THE ANTIMICROBIAL ACTIVITY OF CONTROLLED-RELEASE CHLORINE DIOXIDE GAS ON FRESH BLUEBERRIES.....</b>	<b>57</b>
Abstract .....	58
Introduction.....	59
Materials and Methods .....	61
Results and Discussion .....	66
Conclusion.....	70
<b>CHAPTER 6 SUNMMARY AND FUTURE DIRECTIONS.....</b>	<b>75</b>
Summary .....	75
Future Directions .....	76
References.....	78
Abstract.....	100
Autobiographical Statement .....	102

## LIST OF TABLES

Table 1-1 Examples of some known active packaging systems.....	8
Table 1-2 Antimicrobials and preservatives.....	9
Table 3-1 Mechanical properties of the edible gallic acid-chitosan and chitosan-only films.....	35
Table 3-2 WVP and OP of the edible gallic acid-chitosan and chitosan-only films .....	36
Table 4-1 Antimicrobial activity of CIN, CAR, BEN, ECIN, EUG and EUC on the growth of <i>E.coli</i> and <i>P. digitatum</i> determined by vapor-based test.....	53
Table 4-2 Inhibition activity of CIN, CAR, BEN, ECIN, EUG and EUC on the growth of <i>E.coli</i> and <i>P. digitatum</i> tested by direct liquid contact-based inhibition zone method.....	54
Table 4-3 Effects of edible coatings enriched with essential oils on antimicrobial activities of fresh blueberries at 0.5% under different storage conditions.....	55
Table 5-1 Effect of ClO <sub>2</sub> on growth of <i>E.coli</i> and <i>C. acutatum</i> .....	75



## LIST OF FIGURES

Figure 1-1 Structure of (A) chitin and (B) chitosan.....	10
Figure 3-1 Antimicrobial properties of the edible gallic acid-chitosan versus chitosan-only films.....	31
Figure 3-2 FT-IR spectra of the edible gallic acid-chitosan and chitosan-only films.....	32
Figure 3-3 SEM of surface of the edible gallic acid-chitosan and chitosan-only films...	33
Figure 3-4 SEM of the cross-section of the edible gallic acid-chitosan and chitosan-only films.....	34
Figure 4-1 Effects of chitosan coating combined with CAR or ECIN on enumerated mesophilic aerobic bacteria (a and c) and yeasts and molds (b and d) of fresh blueberries during storage at 10 °C for up to 7 d.....	56
Figure 4-2 Effects of edible coatings enriched with CAR (a) or ECIN (b) on firmness of fresh blueberries during storage at 10 °C for up to 7 d.....	57
Figure 5-1 <i>In vitro</i> antimicrobial activity-chamber method to test the efficiency of ClO <sub>2</sub> against <i>E.coli</i> and <i>C. acutatum</i> .....	72
Figure 5-2 Effects of ClO <sub>2</sub> pad on antimicrobial activities of fresh blueberries under different storage conditions.....	73
Figure 5-3 Effects of ClO <sub>2</sub> pad on firmness of fresh blueberries under different storage conditions.....	74

## CHAPTER 1 INTRODUCTION

### Active Packaging

Active packaging, sometimes referred to as interactive or intelligent packaging, is packaging in which subsidiary constituents have been deliberately included in or on either the packaging material or the package headspace to improve the performance of the package system (Alvarez 2000). Active packaging emphasizes the importance of deliberately including a substance with the intention of enhancing the food product, and it is commonly used to protect against oxygen and moisture (Brody 2010).

In the recent past, food packaging was used to enable marketing of products and to provide passive protection against environmental contaminations or influences that affect the shelf life of the products (Ozdemir and Floros 2008). However, unlike traditional packaging, which must be totally inert, active packaging is designed to interact with the contents and/or the surrounding environment, to improve sensory properties or inhibit the growth of pathogenic and spoilage microorganisms, which provides great benefits to the food industry to improve freshness, shelf-life of food, and allows monitoring to control the storage conditions from the place of production to consumption by the final consumer (de Abreu and others 2012).

Active packaging technologies include some physical, chemical, or biological action which changes interactions between a package, product, and/or headspace of the package in order to get a desired outcome (Yam and others 2005). Most important active packaging technologies include oxygen and ethylene scavenging, carbon dioxide scavengers and emitters, moisture regulators, antimicrobial packaging, and antioxidant release technologies (Vermeiren and others 1999). Some currently known active

packaging systems are shown in Table 1-1. Antimicrobial packaging appears to be a promising application of active food packaging technology (Chen and Brody 2013). Antimicrobials incorporated in packaging materials could extend shelf life by preventing bacterial growth and spoilage (Labuza and Breene 1989).

Active packaging is typically found in two types of systems: specific active ingredients that are incorporated directly into the packaging polymer-based films or coatings, and sachets and pads which specific additives are placed within the container itself (Liang and Ludescher 2011).

### **Edible Films and Coatings**

An edible film or coating is defined as a thin layer, which can be consumed, coated on a food or placed as barrier between the food and the surrounding environment (Cagri and others 2004). Edible films and coatings, serving as selective barriers to moisture transfer, oxygen and carbon uptake, lipid oxidation, and losses of volatile aromas and flavors, improve mechanical handling properties, food quality and shelf life (Wang and others 2013; Cagri and others 2004; Olivas and Barbosa-Canovas 2005). Their use is gaining important attention in food protection and preservation due to the high demand of consumers for longer shelf-life and better quality of fresh foods as well as of environmentally friendly packaging (Park and Zhao 2004; Wang and others 2014).

Components of edible films and coatings include proteins, cellulose derivatives, alginates, pectin, starches, waxes, composites and other materials (Tharanathan 2003). Addition of emulsifiers (glycerol, Tween-20) reduces superficial water activity and rate of

moisture loss in food products (Baldwin and others 1995). The edible films and coatings are classified into three categories taking into account the nature of their components: hydrocolloids (such as proteins, polysaccharides or alginates), lipids (such as by fatty acids, acylglycerols or waxes) and composites (made by combining substances from the two categories) (Krochta and DeMulderJohnston 1997; Donhowe and Fennema 1993).

The properties of edible films and coatings include (Debeaufort and others 1998; Mchugh and Krochta 1994; Dhall 2013; Dutta and others 2009):

- (1) Safe for health because they are formed from natural substances;
- (2) Reduce environmental pollution problems due to their biodegradability;
- (3) High barrier and mechanical efficiencies to inhibit the transmission of water, oil, and flavor components;
- (4) Suitable biochemical, physical, chemical and microbial stability;
- (5) Enhance the organoleptic, physical and nutritional properties of foods;
- (6) Individual protection of small pieces of foods;
- (7) Simple technology requirement and low cost of raw materials and processing.

One of the most important applications of edible films and coatings is incorporation of bactericidal agents or growth inhibitors into film or coating-forming materials to form antimicrobial films and coatings which may retard surface growth of bacteria, yeasts and molds on a wide range of products (Coma and others 2002; Cagri and others 2004).

Antimicrobial edible films and coatings can serve as carriers for various antimicrobials that can extend shelf-life and reduce the risk of pathogen (Cagri and

others 2004). Some of the more commonly used antimicrobials and preservatives, such as sorbates, acidifying agents, bacteriocins and natural antimicrobial agents, are shown in Table 1-2.

Chitosan is a natural polysaccharide produced by deacetylation of chitin in the presence of alkali. The structures of chitin and chitosan are shown in Figure 1-2. The potential of chitosan to act as a food preservative of natural origin has been widely reported on the basis of *in vitro* trials as well as through direct application on real complex matrix foods. Chitosan is also an excellent film forming material. Chitosan films have a selective permeability to gasses, thereby delaying ripening and decreasing transpiration rates in fresh fruits and vegetables (Elsabee and Abdou 2013a). Chitosan films showed stable mechanical and barrier properties during storage (Butler and others 1996).

Essential oils and oil compounds from various plants have been known to exhibit antibacterial and antioxidant properties (Friedman, Henika, Levin, & Mandrell, 2004, Burt, 2004, Teixeira et al, 2013). Essential oils of cinnamon, cloves, garlic, oregano, rosemary and thyme are inhibitory to various spoilage or pathogenic bacteria, yeasts and molds. The essential oil of thyme and its constituent thymol showed antagonistic effects against *Salmonella typhimurium* and *Staphylococcus aureus* (Juven and others 1994). A decrease in the sensitivity of *Bacillus cereus* towards carvacrol was observed after growth in the presence of non-lethal carvacrol concentrations (Ultee and others 2000). The minimum inhibitory concentration (MIC) of the ethanolic solution of rosemary extract was 1% for *Leuconostoc mesenteroides*, 0.5% for *Listeria monocytogenes*, 0.5% for *Staphylococcus aureus*, 0.13% for *Streptococcus mutans*, 0.06% for *Bacillus cereus*

and 1% for *Escherichia coli* (Del Campo and others 2000). Therefore the incorporation of essential oils and oil compounds into the films or coatings could be an approach to gain functional edible packaging with antioxidant and antibacterial activity.

### **Sachets and Pads**

In order to absorb or emit gases to a package or headspace, sachets and pads are very commonly used. Sachets were developed in the late 1970s in Japan. For oxygen scavenging, the sachets essentially utilize the process of rusting, or the oxidation of iron compounds in the presence of oxygen and water. Oxygen scavengers can also be made based on enzyme technology. Oxygen absorbers are usually made of powdered iron or ascorbic acid. Iron based scavengers typically do not pass the metal detector inspections on most packaging lines, and in these incidences ascorbic acid is advantageous.

Chlorine dioxide is a strong sanitizing and oxidizing agent which has a broad and high biocide effectiveness at low concentrations (Alejandro 2012; Singh 2002). Chlorine dioxide has 2.5 times more oxidizing power as chlorine because it does not hydrolyze in water to form HOCl. Chlorine dioxide and its main by-product are listed as noncarcinogenic products (Richardson 2007; Alejandro 2012), and the use of chlorine dioxide has been caused attention as a potential antimicrobial treatment for vegetables and fruits. Chlorine dioxide has been approved by the U.S. Environmental Protection Agency (EPA) and U.S. Food and Drug Administration (FDA) as a sanitizer, disinfectant, and sterilizer for vegetables and fruits (Burton 2013; Du 2003). Nevertheless, one

disadvantage of chlorine dioxide is that it is unstable and easy to be explored at high concentrations (Silveira 2008).

In recent years, a large quality of research has elaborated on the effect of chlorine dioxide on the reduction of the risk of foodborne infections and intoxications. Chlorine dioxide gas treatment could effectively delay the postharvest physiological transformation of green peppers, inhibit decay and respiration, and maintained nutritional and sensory qualities (Du 2007). The shelf-life of grated carrots was prolonged by chlorine dioxide treatment (Gómez-López 2007). Chlorine dioxide gas could reduce the risk of microbial contamination and control postharvest decays, which is effective for keeping the quality of tomatoes (Mahovic 2007; Trinetta 2010). Chlorine dioxide treatment could significantly inhibit the growth of *E. coli* O157:H7, which has benefit effect to public health (Du 2003; Han 2004; Lee 2004; Mahmoud 2007; Singh 2002; Padhye 1991). The inactivation mechanism of chlorine dioxide was figured out that chlorine dioxide could disrupt protein synthesis or increase the permeability of the outer membrane by reacting with the membrane protein and lipids (Mahmoud 2007).

**Table 1-1. Examples of some known active packaging systems**

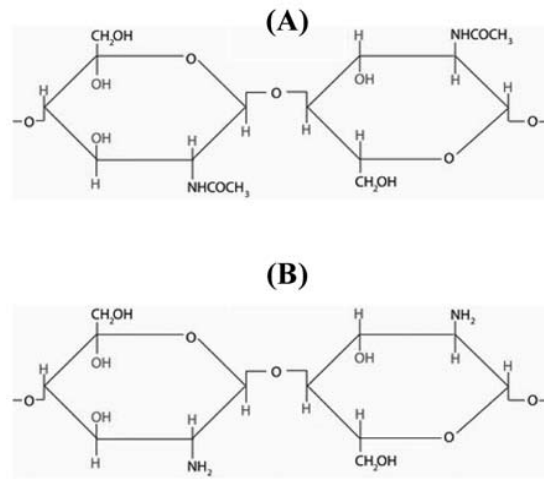
Type of active packaging systems	Substances used and mode of action
Oxygen absorbing	Enzymatic systems Chemical systems
Carbon dioxide absorbing/emitting	Iron power-calcium hydroxide Ferrous carbonate-metal halide
Moisture absorbing	Silica gel Propylene glycol Polyvinyl alcohol
Ethylene absorbing	Activated charcoal
Antimicrobial releasing	Sorbates Ethanol Antimiotics Benzoates
Antioxidant releasing	BHA BHT Ascorbic acid Tocopherol



**Table 1-2. Antimicrobials and preservatives**

Antimicrobial	Main target microorganism
<b>Organic acids</b> Sorbic Acetic Malic Benzoic	Moulds
<b>Inorganic gases:</b> Sulfur dioxide Chlorine dioxide	Moulds Bacteria Yeasts
<b>Bacteriocins:</b> Nisin Lacticins Pediocins	Gram-positive bacteria
<b>Essential oils:</b> Carvacrol Cinnamaldehyde Eugenol Benzaldehyde Eucalyptol	Moulds Bacteria Yeasts
<b>Enzymes:</b> Lysosine Glucose oxidase	Gram-positive bacteria

Figure 1-1. Structure of (A) chitin and (B) chitosan ((Muzzarelli 1996)



## CHAPTER 2 BACKGROUND AND SPECIFIC AIMS

### Background

The interest in the development of active packaging has recently been steadily increasing due to significant concerns about environmental pollution caused by non-biodegradable packaging materials and consumer demand for high quality food products. Newly developed packaging materials often have additional functional properties, such as antioxidant and antimicrobial properties, beyond their essential mechanical properties. Antimicrobial packaging, especially natural antimicrobial packaging, is showing a great potential in the future of active packaging systems through its promising proposed impact on shelf-life extension and food safety, via controlling spoilage and the growth of pathogenic microorganisms, it also reduces the environmental pollution caused by the manufacture of other preservatives. Therefore, research on new functional edible, biodegradable and inexpensive packaging materials and methods should yield numerous potential applications

### Specific Aim 1

Using chitosan and gallic acid to develop edible films and characterize their functional properties.

1a. The development of antimicrobial chitosan-gallic acid films. The chitosan-gallic acid films were developed by dissolving chitosan in 1% acetic acid, and then added three different concentrations of gallic acid. Glycerol at 0.3% (W/W) was added as a plasticizer.

1b. Test the antimicrobial, mechanical, physical and structural properties of the chitosan-gallic acid film. The films were investigated for antimicrobial properties using four bacterial strains; mechanical properties by testing tensile strength and elongation; physical properties by testing water vapor permeability and oxygen permeability; and structural properties by Fourier transform infrared spectroscopy (FT-IR) and scanning electron microscopy (SEM).

## **Specific Aim 2**

Using chitosan and essential oils to develop antimicrobial edible coatings.

2a. Comparison of antimicrobial activity of six essential oils (trans-cinnamaldehyde (ECIN), carvacrol (CAR), cinnamaldehyde (CIN), benzaldehyde (BEN), eugenol (EUG), and eucalyptol (EUC)) using chamber method and agar diffusion method.

2b. The development of antimicrobial chitosan-essential oil coatings. The chitosan-essential oil coatings were developed by dissolving chitosan in 1% acetic acid, and then incorporated with different essential oils.

2c. Test antimicrobial properties and the application of the coatings in the preservation of post-harvest fruits. Chitosan coatings plus different essential oils were applied to fresh blueberries. The antimicrobial activities of the coatings and fruit firmness were evaluated.

### Specific Aim 3

To develop a new active antimicrobial packaging based on chlorine dioxide sachet.

3a. To do *in vitro* antimicrobial activity test of chlorine dioxide. Chamber and agar diffusion methods were used for an *in vitro* investigation of antimicrobial activity of chlorine dioxide.

3b. The application of chlorine dioxide sachet on the packaging. The effect of chlorine dioxide sachet on the safety and quality of blueberries was studied.

## CHAPTER 3 THE ANTIMICROBIAL, MECHANICAL, PHYSICAL AND STRUCTURAL PROPERTIES OF CHITOSAN-GALLIC ACID FILMS

Xiuxiu Sun <sup>a</sup>, Zhe Wang <sup>b</sup>, Hoda Kadouh <sup>a</sup>, Kequan Zhou <sup>a,\*</sup>

<sup>a</sup> Department of Nutrition and Food Science, Wayne State University, Detroit, MI 48202,  
United States

<sup>b</sup> School of Biological and Agricultural Engineering, Jilin University, No. 5988 Renmin  
Street, Changchun, Jilin 130025, China

\*Corresponding author: kzhou@wayne.edu (313-577-3444)

**KEY WORDS:** Chitosan, gallic acid, antimicrobial activity, mechanical properties, edible  
film

**Published in: LWT-Food Science and Technology 57 (2014), 83-89**

## Abstract

Chitosan films incorporated with various concentrations of gallic acid were prepared and investigated for antimicrobial, mechanical, physical and structural properties. Four bacterial strains that commonly contaminate food products were chosen as target bacteria to evaluate the antimicrobial activity of the prepared gallic acid-chitosan films. The incorporation of gallic acid significantly increased the antimicrobial activities of the films against *Escherichia coli*, *Salmonella typhimurium*, *Listeria innocua* and *Bacillus subtilis*. Chitosan films incorporated with 1.5 g/100 g gallic acid showed the strongest antimicrobial activity. It was also found that tensile strength (TS) of chitosan film was significantly increased when incorporating 0.5 g/100 g gallic acid. Inclusion of 0.5 g/100 g gallic acid also significantly decreased water vapor permeability (WVP) and oxygen permeability (OP). Microstructure of the films was investigated by Fourier transform infrared spectroscopy (FT-IR) and scanning electron microscopy (SEM) and it was found that gallic acid was dispersed homogenously into the chitosan matrix.

## Introduction

The interest in the development of edible and biodegradable films for food packaging has recently been steadily increasing due to significant concerns about environmental pollution caused by non-biodegradable packaging materials and consumer demand for high quality food products (Bravin and others 2006). Newly developed packaging materials often have additional functional properties, such as antioxidant and antimicrobial properties, beyond their essential mechanical properties (Bajpai and others 2010; Suppakul and others 2003). Antimicrobial packaging is showing a great potential in the future of active packaging systems through its promising proposed impact on shelf-life extension and food safety, via controlling spoilage and the growth of pathogenic microorganisms (Moreira and others 2011). Therefore, research on new functional edible and biodegradable packaging materials should yield numerous potential applications.

Chitosan is a natural polysaccharide produced by deacetylation of chitin, which is the structural element of the crustacean's shell, insect's cuticle and cell walls of fungi. Chitosan films have been successfully developed and used for packaging foods such as fruits, vegetables, and meats (Chien and others 2007; Moreira and others 2011; Darmadji and Izumimoto 1994). The elastic and transparent chitosan films are known for their solid mechanical properties and selective permeability for gases (Pereda and others 2012). Moreover, they are less sensitive to water in comparison with hydroxylpropyl methylcellulose films (Sebti and others 2007). These non-toxic, biodegradable, and biocompatible films also have unique antimicrobial properties (Durango and others 2006). However, for certain food products, the limited antimicrobial



activity of pure chitosan films does not reach the antiseptic level desired by packers (Ye and others 2008). For example, to enhance the efficacy of chitosan film against foodborne pathogens, nisin, potassium sorbate, and sodium benzoate, have been incorporated into the chitosan coating to extend the shelf-life of frankfurters (Samelis and others 2002). The incorporation of an additional antimicrobial agent could enhance its antimicrobial activity and expand the scope of its application.

Different antimicrobial chemicals such as organic acids, inorganic gases, metals or ammonium compounds have been incorporated into plastic packaging materials (Suppakul and others 2003). However, because of environmental problems associated with chemicals and plastics and the health concerns of the consumers, extensive studies have been conducted to use natural bioactive agents including antimicrobial enzymes, essential oils, bacteriocins, and phenolic compounds in biodegradable or edible packaging materials (Ramos-Garcia and others 2012; Vodnar 2012; Coma 2008). For instance, edible chitosan films containing lactoferrin as a natural antimicrobial agent were developed and shown to exhibit significant antimicrobial activity against both *Listeria monocytogenes* and *Escherichia coli* O157:H7 (Brown and others 2008). Chitosan-based formulations with lime or thyme essential oil, beeswax, and oleic acid were found effective in inhibiting *Escherichia coli* DH5a (Ramos-Garcia and others 2012). Others have incorporated oleoresins and tea extracts into chitosan films to improve their antimicrobial activity against *Listeria monocytogenes* (Vodnar 2012).

The use of phenolic compounds and extracts in active packaging attracts a particular interest since these compounds show potent antimicrobial activity in food

systems and their intake can make a contribution to human health (Komes and others 2010). Gallic acid is a widely available phenolic acid that has been shown to possess strong antimicrobial activity (Chanwitheesuk and others 2007). Gallic acid extracted from *Caesalpinia mimosoides* Lamk (Leguminosae) exhibited the activity against the bacteria *Salmonella typhi* and *Staphylococcus aureus* with MIC values of 2.50 and 1.250 g/L, respectively (Chanwitheesuk and others 2007). Gallic acid purified from the flowers of *Rosa chinensis* Jacq. has also been shown to possess significant antibacterial activity against pathogenic *Vibrios* species (Li and others 2007). All of these reports in the literature have indicated promising potential in using gallic acid to develop antimicrobial packaging materials against pathogens and spoilage bacteria.

In addition, gallic acid appears to enhance elasticity, thus acting as a plasticizer and eliminates classical brittleness and flexibility problems (Alkan and others 2011; Hager and others 2012). Gallic acid incorporation during the formation of chitosan-gallic acid polymers yielded a conjugate with a superior hydroxyl radical scavenging capacity (Pasanphan and others 2010). This is an encouraging aspect of gallic acid used in manufacturing food packaging chitosan films. Thus, our purpose is to evaluate the potential to develop a new cost-effective edible chitosan film with improved antimicrobial and mechanical properties by incorporating a widely accessible natural antimicrobial compound.

## **Materials and Methods**

### **Film-making materials**

Chitosan (95-98% deacetylated, MV =8.0×10<sup>5</sup> Da) (Moreira and others 2011) and glacial acetic acid (99%, analytical reagent grade) were obtained from Sigma-Aldrich Co. (St. Louis, MO, USA); Glycerol, as a plasticizing agent, and gallic acid, as an antimicrobial agent, were purchased from Fisher Scientific Inc. (Pittsburgh, PA, USA).

### **Film preparation**

The edible films were prepared by dissolving 1 g of chitosan in 100 g of 1% acetic acid solution and stirred, at room temperature, until chitosan was completely dissolved. Glycerol at 0.3 g/100 g was added as a plasticizer. Film without gallic acid was designated as film 0 (F0) which was used as a control. Gallic acid was added at varying concentrations: 0.5 g/100 g in film 1 (F1), 1.0 g/100 g in film 2 (F2) and 1.5 g/100 g in film 3 (F3), respectively. Equal volumes (150 mL) of the film solutions were spread on glass plates (200 × 200 mm) and dried for 12 h at 35 ± 2 °C in an incubator (New Brunswick Scientific Excella\* E24, Fisher Scientific Inc. PA, USA). The films were removed from the glass plate with a thin spatula and conditioned at 23 ± 2 °C and 50 ± 2% relative humidity (RH) before running further tests.

### **Bacterial strains and cultures**

Two gram-negative bacteria: *Escherichia coli* 0157:H7 (ATCC 43895) and *Salmonella typhimurium* (ATCC 19585) and two gram-positive bacteria: *Bacillus subtilis* (ATCC 1254) and *Listeria innocua* (F4078) were used. *E. coli* was incubated in Luria-Bertani (LB) broth media, *B. subtilis* and *L. innocua* were incubated in Nutrient broth

media, and *S. typhimurium* was incubated in Brain-heart infusion (BHI) broth media at 37 °C for 24 h.

### **Antimicrobial activity**

Antimicrobial properties of the crafted films were determined by the log reduction method with a slight modification (Ravishankar and others 2009). Briefly, culture medium broth was inoculated with 1% suspension of bacteria. The bacterial concentration in the seeding culture was approximately  $6 \times 10^8$  CFU/mL. Serial dilutions of the suspension were performed and the optical density values were tested to achieve a standard curve. Square film pieces (20 × 20 mm) were sterilized and introduced into a test tube containing 5 mL fresh suspension of bacteria and incubated at 37 °C for 24 h. Optical density of culture media was measured at 620 nm using a Perkin-Elmer HTS 7000 Bio Assay reader, and cell concentrations were determined. All samples/standards were run in triplicates.

### **Film thickness (FT)**

FT was measured with a 0-25 mm dial thickness gauge with an accuracy of  $\pm 0.01$  mm in five random locations for each film. Averages were calculated for mechanical properties, water vapor permeability and oxygen permeability.

### **Mechanical properties**

Tensile strength (TS) and elongation at break (EB) tests were performed at room temperature ( $23 \pm 2$  °C) using a universal testing machine (PARAM XLW (B) Auto Tensile Tester, Jinan, China) with a 200 N load cell according to the standard testing

method ASTM D882-01 (ASTM, 2001). Sample films, previously equilibrated at  $23 \pm 2$  °C and  $50 \pm 2\%$  RH, were cut into strips 15 mm wide and 130 mm long. Five specimens from each film were tested. The initial grip separation and mechanical crosshead speed were set at 80 mm and 50 mm/min, respectively.

TS (MPa) was calculated using the following equation:

$TS = F_{max}/A$ ; where  $F_{max}$  is the maximum load (N) needed to pull the sample apart;  $A$  is cross-sectional area ( $m^2$ ) of the samples.

EB (%) was calculated using the following equation:

$EB = (L/80) \times 100$ ; where  $L$  is the film elongation (mm) at the moment of rupture; 80 is the initial grip length (mm) of samples.

## Physical properties

### Water vapor permeability (WVP)

The WVP of the films was determined by a Water Vapor Permeability Tester (PERME TSY-TIL, Labthink Instruments Co., Ltd, Jinan, China) according to the standard testing method ASTM E-96-95 (ASTM, 1995). Test cups were 2/3 filled with distilled water. The test cups were tightly covered with circular film samples. Difference in water vapor pressure between the inside and outside of the cup causes water vapor diffusion through the sample. For each sample, five replicates were tested. The weight of the cups was measured at 1 h intervals for 24 h. Simple linear regression was used to estimate the slope of weight loss versus time plot.

WVP ( $g \cdot m^{-1} \cdot s^{-1} \cdot Pa^{-1}$ ) was calculated using the following equation (Sztuka and Kolodziejka 2009):  $WVP = (WVTR \times L) / \Delta p$ ; where  $WVTR$  (water vapor transmission

rate) is slope/film test area ( $\text{g/m}^2\cdot\text{s}$ );  $L$  is film thickness (m);  $\Delta p$  is partial water vapor pressure difference (Pa) between the two sides of the film.

### **Oxygen permeability (OP)**

OP of the films was determined by a Gas Permeability Tester (GDP-C) (Brugger Feinmechanik GmbH, Germany) according to the standard testing method ASTM D3985-05 (ASTM, 2005). An edible film was mounted in a gas transmission cell to form a sealed semi-barrier between chambers. Oxygen enters the cell on one side of the film from a chamber which is at a specific high pressure and leaves from the other which is at a specific lower pressure with a controlled flow rate (100 mL/min). The lower pressure chamber was initially evacuated and the transmission of oxygen through the test specimen was indicated by an increase of pressure. For each sample, at least five replicates were tested. OP ( $\text{mol}\cdot\text{m}^{-1}\cdot\text{s}^{-1}\cdot\text{Pa}^{-1}$ ) was calculated using the following equation (Ayranci and Tunc 2003):

$OP = (M \times L) / (A \times T \times \Delta p)$ ; where  $M$  is the volume of gas permeated through the film (mol);  $L$  is film thickness (m);  $A$  is the area of the exposed film surface ( $\text{m}^2$ );  $T$  is the measured time interval (s);  $\Delta p$  is difference (Pa) between the two sides of the film.

### **Microstructure properties**

#### **Fourier transform infrared spectroscopy (FT-IR)**

FT-IR was recorded on a Spectrum 400 FT-IR spectrometer (PerkinElmer Inc., USA). Films were placed on the steel plate and measured directly in a spectral range of 650 to 4000  $\text{cm}^{-1}$  at the resolution of 4  $\text{cm}^{-1}$ , and the average of 128 scans was taken for each sample.

## Scanning electron microscopy (SEM)

The films were cut into small pieces (10 × 10 mm), dried and mounted on aluminum stubs using a double-sided adhesive carbon tape and sputtered with a thin layer of gold. Microstructures of the surface and cross-section of the dried films were observed by a Scanning Electron Microscope (SEM, JSM-6510LV-LGS, JEOL Co., Ltd. USA) and Field Emission Scanning Electron Microscope (FESEM, JSM-7600F, JEOL Co., Ltd. USA), respectively. All samples were examined at an accelerating voltage of 15 KV and magnified 10,000 X.

## Statistical analysis

Analysis of variance (ANOVA) was carried out using SPSS software (version 17). When the p-value was less than or equal to 0.05, the results were considered significant.

## Results and Discussion

### Antimicrobial properties

To examine the antimicrobial properties of the studied edible films, *E. coli*, *S. typhimurium*, *B. subtilis*, and *L. innocua*, which are very significant pathogens in the food industry, were tested. The results are shown in Fig. 3-1. The edible films incorporated with different concentrations of gallic acid significantly improved the antimicrobial activities of the chitosan film against all the tested bacteria ( $p < 0.05$ ). The log reduction increases with the increase of gallic acid concentration, which illustrates the antimicrobial activity of gallic acid.

The results show that the log reductions of *B.subtilis*, ranged from 1.24 to 5.75, are demonstrated to be higher than other bacteria. The minimum inhibitory concentration (MIC) of chitosan against *B. subtilis* is 0.10 g/L (Yadav and Bhise 2004). The log reductions of *E. coli* range from 0.57 to 2.31. The MIC of chitosan against *E. coli* is 0.75 mg/mL (Tao and others 2011) and gallic acid demonstrated significant antimicrobial activity against *E. coli* (MIC=1 g/L) (Binutu and Cordell 2000). Combining gallic acid with chitosan shows a potent antimicrobial effect according to our results. The log reductions of *S. typhimurium* ranged from 1.07 to 1.75. Furthermore, the combination of gallic acid in chitosan films exhibited obvious reduction in the growth of *L. innocua*, resulting in an approximate 2.5-log reduction. *Listeria* growth inhibition was recorded for gallic acid at 0.45 g/L (Aissani and others 2012). The diameters of the zone of inhibition (mm) of chitosan against *E. coli* and *B. subtilis* were 18 mm and 40 mm respectively (Yadav and Bhise 2004), which verified that *B. subtilis* is more sensitive than *E. coli* to chitosan.

Furthermore, the film showed a higher effectiveness against *B. subtilis* and *L. innocua* compared to *E. coli* and *S. typhimurium* which may be rationalized by the characteristic difference of the outer membrane between Gram-positive bacteria and Gram-negative bacteria (Ramos and others 2012).

### **Mechanical properties**

Mechanical properties are important to edible films, because adequate mechanical strength ensures the integrity of the film and its freedom from minor defects (Murillo-Martinez and others 2011). Table 1 shows mechanical property values of four



edible films after conditioning at  $23 \pm 2$  °C and  $50 \pm 2\%$  RH. Differences in the TS and EB of F0, F1, F2 and F3 were observed and could be attributed to the addition of gallic acid interacting with chitosan and forming new linkages that affect film structure.

Our chitosan control film (F0) had TS and EB values of 13.876 MPa and 32.36%, respectively (Table 3-1). These values are comparable to the previous reports with TS and EB in the range of 12-20 MPa and 17-42%, respectively (Vargas and others 2009). The TS and EB of chitosan films are affected by the type of chitosan used, the presence of glycerol, and the temperature during film drying (Pereda and others 2012). Interestingly, the incorporation of 0.5 g/100 g and 1.0 g/100 g gallic acid into chitosan films significantly increased its TS ( $P < 0.05$ ). The addition of a relatively lower dose of gallic acid (F1) exhibited the highest TS among the films, which could be attributed to the formation of intermolecular hydrogen bonding between the  $\text{NH}_3^+$  of the chitosan backbone and the  $\text{OH}^-$  of gallic acid (Sun and others 2011). The intermolecular hydrogen bonding between chitosan and gallic acid could enhance the cross-linkage, which decreases the molecular mobility and the free volume of chitosan (Pasanphan and Chirachanchai 2008). This phenomenon was reported by other researchers in similar systems. For example, the cross-linking of chitosan-olive oil emulsion as well as chitosan-oleic acid films resulted in an increased TS due to the enhancement of the structural bonds in the polymer network (Pereda and others 2012; Vargas and others 2009). However, when the added concentration of gallic acid is higher than 0.5 g/100 g, the TS of the resulting films decreased with increasing gallic acid concentration. As we can see, the TS of F3 (9.207 MPa) was lower than that of F0 (13.876 MPa). It is

possible that the excessive gallic acid scattered in the film crack the inner structure of the film (Fig. 3-3d and Fig. 3-4d).

The decrease of EB values in F1-F3 films indicated that the incorporation of gallic acid into the chitosan film resulted in a strong reaction between filler and matrix, which decreased EB by the motion restriction of the matrix. The decreased EB values from 20% to 6% of chitosan films indicated that the incorporation of cellulose whiskers into the chitosan matrix resulted in strong interactions between matrix and filler, which restricted the motion of the matrix (Li and others 2009).

## **Physical properties**

### **Water vapor permeability (WVP)**

Table 3-2 shows there was a significant difference between the WVP values of F0-F3 films incorporated with different gallic acid concentrations ( $p < 0.05$ ). When the added gallic acid was below 1.0 g/100 g, the WVP values of the films decreased significantly ( $p < 0.05$ ) with increasing gallic acid concentrations, which could be because the bulky benzene ring group of gallic acid obstructs the inter- and intramolecular hydrogen bond network of chitosan (Pasanphan and Chirachanchai 2008). However, when the concentration of gallic acid was higher than 1.0 g/100 g, the WVP of the film increased ( $p < 0.05$ ), which may be related to the excessive gallic acid scattered in the film (Fig. 3-3d and Fig. 3-4d) which subsequently decreased the intermolecular forces between polymer chains and increased the free volume and segmental motions (Sothornvit and Krochta 2001). In addition, carboxyl groups and hydroxyl groups of

gallic acid are hydrophilic groups, which might promote water transfer in the matrix (Sanchez-Gonzalez and others 2010).

The WVP values of our crafted films were in the similar range of the previous reports (Sanchez-Gonzalez and others 2010; Pereda and others 2012). In general, the WVP of chitosan films is lower than that of corn-zein film and wheat gluten film, but higher than that of hydroxypropylmethyl cellulose film (Park and Chinnan 1995). Nonetheless, the WVP values of the films are all in the order of  $10^{-10} \text{ g}\cdot\text{m}\cdot\text{s}^{-1}\cdot\text{m}^{-2}\cdot\text{Pa}^{-1}$ , which are qualified for preventing migration of moisture from fruits or vegetables.

### **Oxygen permeability (OP)**

Oxygen is an essential component of lipid oxidation, which decreases food quality and shortens shelf life (Sothornvit and Krochta 2000). The OP values of the chitosan edible films are shown in Table 3-2. The incorporation of gallic acid into the films plays an important role in the improvement of OP. From the results, the OP value of F1 is the lowest, which is significantly different from other films ( $p < 0.05$ ). The OP value of F3 is  $1.39 \times 10^{-18} \text{ mol}\cdot\text{m}^{-1}\cdot\text{s}^{-1}\cdot\text{Pa}^{-1}$ , being the highest, indicates that F3 is not qualified for good oxygen prevention properties compared with the other films. The high OP value of F3 might be due to the non-cross-linking gallic acid particles scattered in the film which may have decreased the intermolecular forces between polymer chains, thus increasing the free volume and segmental motions (Sothornvit and Krochta 2001), and resulting in the formation of pores. This result can also be verified by Fig. 3-3d and Fig. 3-4d, where obvious pores are shown. The OP values of these films ranging from 0.50 to  $1.46 \times 10^{-18} \text{ mol}\cdot\text{m}^{-1}\cdot\text{s}^{-1}\cdot\text{Pa}^{-1}$  show a better oxygen prevention property compared

to wheat gluten film ( $34.6 \times 10^{-18} \text{ mol}\cdot\text{m}^{-1}\cdot\text{s}^{-1}\cdot\text{Pa}^{-1}$ ) and soy protein film ( $31.5 \times 10^{-18} \text{ mol}\cdot\text{m}^{-1}\cdot\text{s}^{-1}\cdot\text{Pa}^{-1}$ ) (Choi and Han 2002; Mehyar and Han 2004).

## Microstructure properties

### Fourier transform infrared spectroscopy (FT-IR)

FT-IR spectroscopy was employed to analyze the hydrogen bonds in the films. The FT-IR spectra of control films and films containing gallic acid were shown in Fig. 3-2. Figure 3-2a shows the F0 film spectrum, which is similar to the chitosan films developed by others (Li and others 2009).

To facilitate the coupling reaction with primary amine groups in chitosan, the carboxylic group of gallic acid is activated by converting the carboxylic acid group into ester, as reported previously (Lee and others 2005). Gallic acid could be conjugated at C-2 to obtain an amide linkage, or at C-3 and C-6 to obtain an ester linkage (Pasanphan and Chirachanchai 2008). The spectra of F1, F2 and F3 films showed significant peaks around  $1700 \text{ cm}^{-1}$  and  $1640 \text{ cm}^{-1}$ , while F0 did not. These peaks correspond to ester and amide linkages between chitosan and gallic acid, respectively (Pasanphan and Chirachanchai 2008). Detected ester and amide linkages are unlikely due to either gallic acid or chitosan individually (Yu and others 2011). These results suggest the conjugation of the gallate group with chitosan in the films. A sharp peak at  $3267 \text{ cm}^{-1}$ , detected only in F3 but not in the other films, corresponds to -OH group. The peaks at  $1610 \text{ cm}^{-1}$ ,  $1201 \text{ cm}^{-1}$  and  $1021 \text{ cm}^{-1}$  referred to the C=O, C-O, and O-H respectively. These peaks demonstrated the presence of -COOH in F3, which indicates the existence of excessive gallic acid in F3. From these results, it can be concluded that the gallate group of gallic acid was successfully cross-linked with chitosan via amide and ester

linkages for F1 and F2, though there was more than enough unreacted gallic acid in F3 (Fig. 3-3d and Fig. 3-4d).

### **Scanning electron microscopy (SEM)**

SEM was employed to observe the films' surface morphology and cross-section as well as the homogeneity of the composite, the presence of voids, and the homogeneous structure of the films (Khan and others 2012). The surface and cross-section morphologies of the films are shown in Fig. 3-3 and Fig. 3-4, respectively. Figure 3-3a and 3-3b shows a flat and smooth appearance and a good compact structure of the F0 and F1 films, respectively, which indicates that the mixtures of chitosan and glycerol, as well as chitosan, glycerol and gallic acid are homogenous in these films. This is further supported by Fig. 3-4a and Fig. 3-4b, where the cross-section morphologies of both F0 and F1 films are also smooth. In Fig. 3-3c, the appearance of a white spot suggests some heterogeneity in the chitosan matrix when gallic acid was incorporated into chitosan. This phenomenon is further verified by Fig. 3-4c, where some bands are presented. Figure 3-3d and Fig. 3-4d show abundant plaques and obvious pores which interrupt the inner structure of the film (F3), therefore reducing the tensile strength and elongation at break by 33.6% and 66.1% compared to the pure chitosan film (F0), respectively. The interrupted inner structure also affects the permeability of the film (F3): the water vapor permeability and oxygen permeability were increased by 47.2% and 3.0%, respectively. Overall, these figures suggest that the films with lower concentrations of gallic acid (F1 and F2) have better mechanical and barrier properties compared to the film added with 1.5 g/100 g gallic acid (F3). Meanwhile, our results agree with the concept that surface properties are important to the barrier

properties of films, where a homogeneous and smooth surface is usually preferred (Wang and others 2013). Water permeability and moisture sensitivity of edible film were directly affected by its surface properties and hydrophobicity (Wu and others 2003). For instance, films casted from unmodified zein showed higher water permeability and moisture sensitivity than modified zein films partially because the former films had larger water surface contact angles, while the modified zein films had stronger surface hydrophobicity through the acylation reaction (Shi and others 2011).

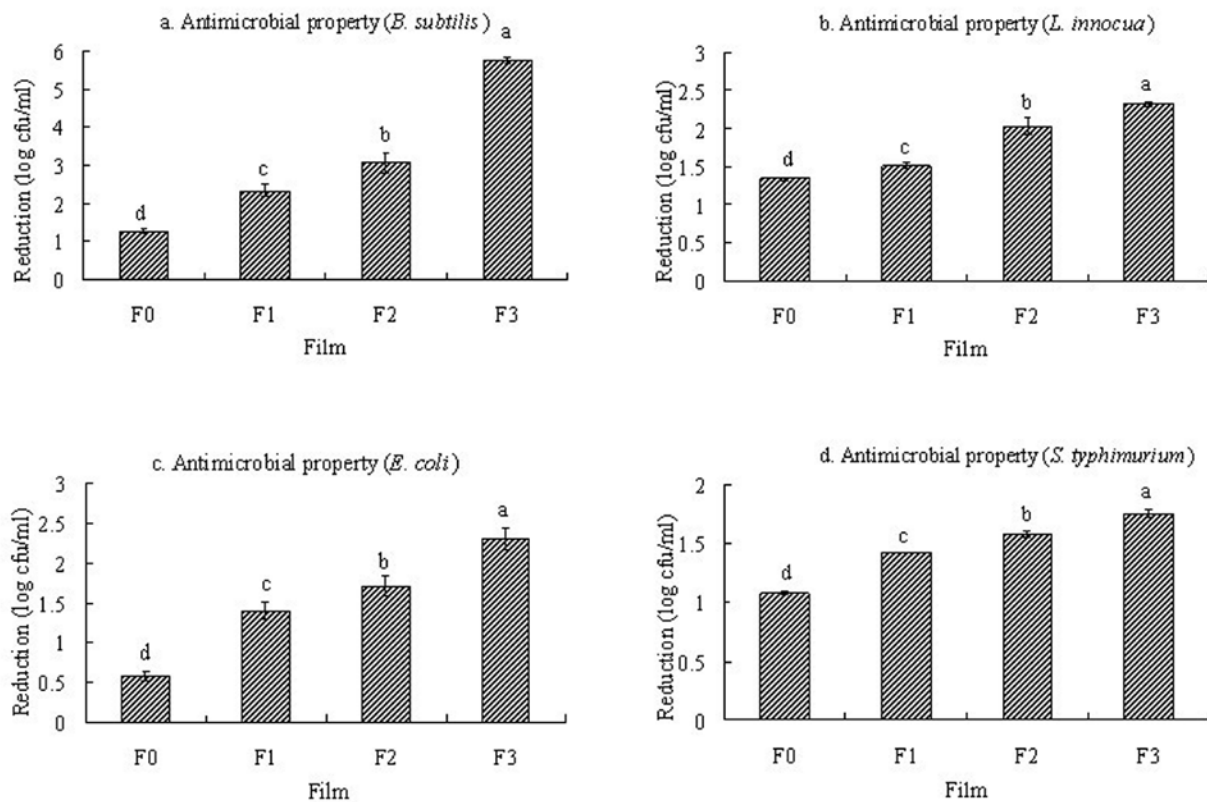
## **Conclusion**

The results of this study suggest that chitosan films incorporated with gallic acid improved the antimicrobial properties of the film significantly, and the films reduced microbial growth by 2.5-log reduction. Furthermore, incorporation of lower concentrations of gallic acid (0.5 g/100 g) increased the TS of the chitosan film by 71.3%. It also improved the barrier properties of chitosan film by reducing WVP and OP by 11.1% and 58.5%, respectively. Surface morphology of the film with lower gallic acid concentration revealed a homogeneous structure. Overall, chitosan films with gallic acid could be used as novel food packaging material due to their excellent antimicrobial and mechanical properties.

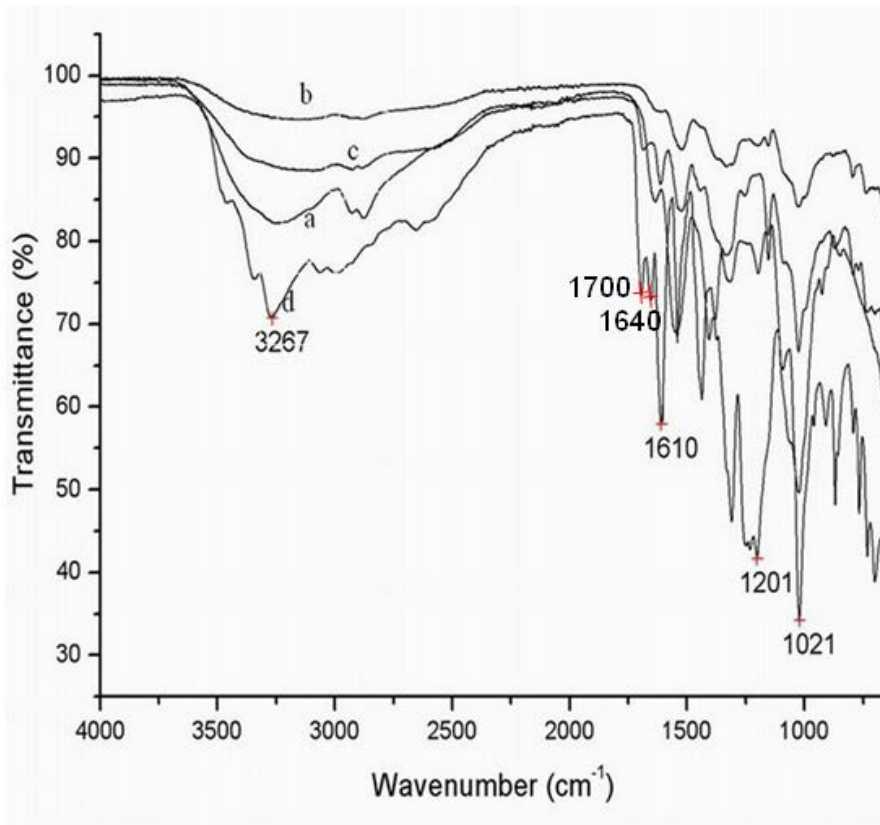
## **Acknowledgements**

Authors recognize and appreciate the financial support from Wayne State University Graduate Research Fellow (UGRF).

**Figure 3-1. Antimicrobial properties of the edible gallic acid-chitosan versus chitosan-only films** (The log reduction of cell number of *B. subtilis* (a), *L. innocua* (b), *E. coli* (c), and *S. typhimurium* (d)). F0 represents the edible film casted from chitosan without gallic acid; F1 represents edible film casted from chitosan with 0.5 g/100 g gallic acid (w/v); F2 represents edible film casted from chitosan with 1.0 g/100 g gallic acid (w/v); F3 represents edible film casted from chitosan with 1.5 g/100 g gallic acid (w/v). Bars with different letters indicate significant difference ( $p < 0.05$ ).

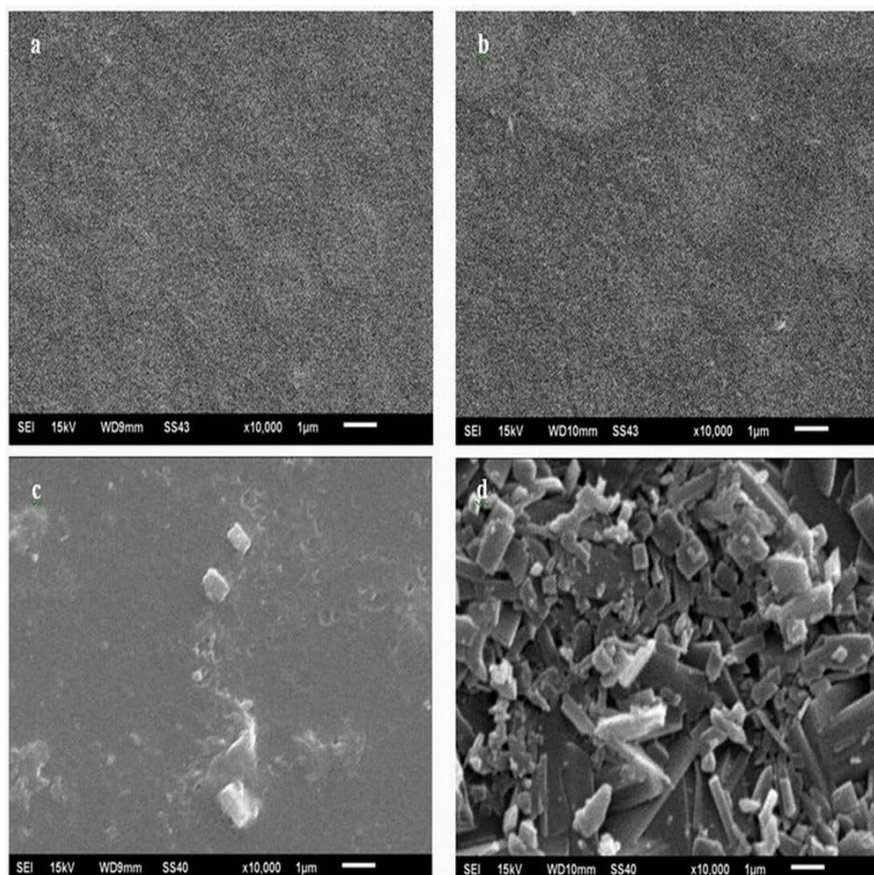


**Figure 3- 2. FT-IR spectra of the edible gallic acid-chitosan and chitosan-only films** (a. represents the edible film casted from chitosan without gallic acid; b. represents edible film casted from chitosan with 0.5 g/100 g gallic acid (w/v); c. represents edible film casted from chitosan with 1.0 g/100 g gallic acid (w/v); d. represents edible film casted from chitosan with 1.5 g/100 g gallic acid (w/v)).

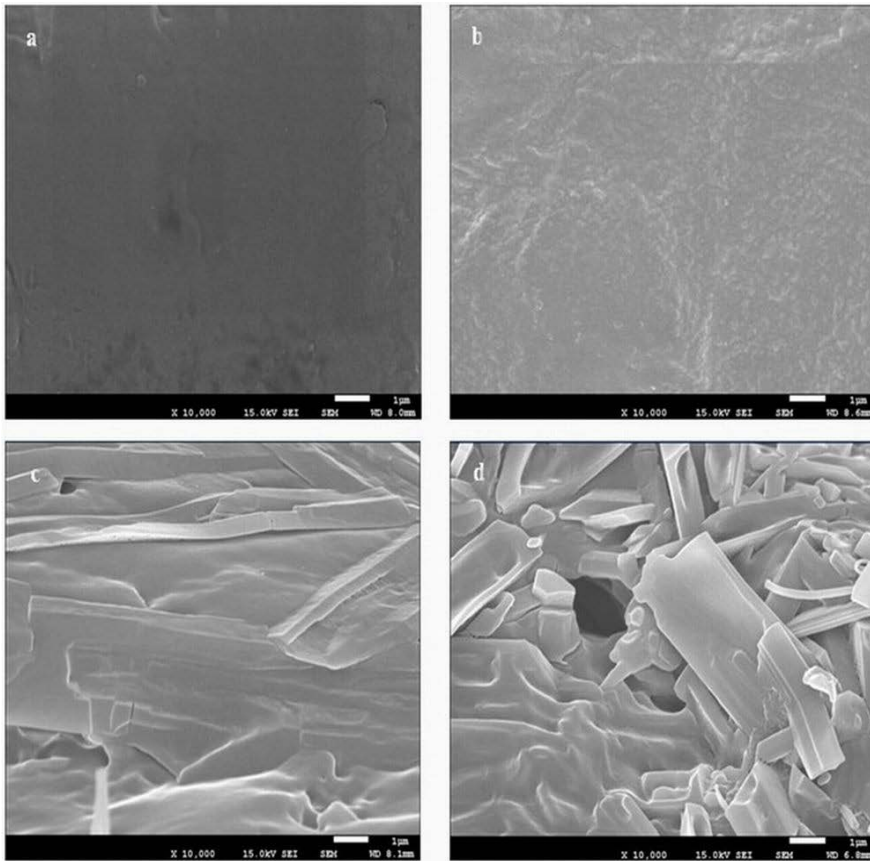




**Figure 3-3. SEM of surface of the edible gallic acid-chitosan and chitosan-only films** (a. represents the edible film casted from chitosan without gallic acid; b. represents edible film casted from chitosan with 0.5 g/100 g gallic acid (w/v); c. represents edible film casted from chitosan with 1.0 g/100 g gallic acid (w/v); d. represents edible film casted from chitosan with 1.5 g/100 g gallic acid (w/v)).



**Figure 3-4. SEM of the cross-section of the edible gallic acid-chitosan and chitosan-only films** (a. represents the edible film casted from chitosan without gallic acid; b. represents edible film casted from chitosan with 0.5 g/100 g gallic acid (w/v); c. represents edible film casted from chitosan with 1.0 g/100 g gallic acid (w/v); d. represents edible film casted from chitosan with 1.5 g/100 g gallic acid (w/v)).



**Table 3-1. Mechanical properties of the edible gallic acid-chitosan and chitosan-only films**

Film code	FT (mm)	TS (MPa)	EB (%)
F0	0.107 ± 0.006 <sup>b</sup>	13.876 ± 0.604 <sup>c</sup>	32.36 ± 1.18 <sup>a</sup>
F1	0.108 ± 0.009 <sup>b</sup>	23.773 ± 0.453 <sup>a</sup>	33.15 ± 2.53 <sup>a</sup>
F2	0.111 ± 0.001 <sup>b</sup>	18.394 ± 1.405 <sup>b</sup>	25.56 ± 0.58 <sup>b</sup>
F3	0.141 ± 0.001 <sup>a</sup>	9.207 ± 0.616 <sup>d</sup>	10.97 ± 0.95 <sup>c</sup>

F0 represents edible film casted from chitosan without gallic acid; F1 represents edible film casted from chitosan with 0.5 g/100 g gallic acid (w/v); F2 represents edible film casted from chitosan with 1.0 g/100 g gallic acid (w/v); F3 represents edible film casted from chitosan with 1.5 g/100 g gallic acid (w/v). Superscripts in same column with different letters indicate significant differences ( $p < 0.05$ ).

**Table 3-2. WVP and OP of the edible gallic acid-chitosan and chitosan-only films**

Film code	FT (mm)	WVP ( $\text{g}\cdot\text{m}^{-1}\cdot\text{s}^{-1}\cdot\text{Pa}^{-1}$ ) $\times 10^{-10}$	OP ( $\text{mol}\cdot\text{m}^{-1}\cdot\text{s}^{-1}\cdot\text{Pa}^{-1}$ ) $\times 10^{-18}$
F0	0.107 $\pm$ 0.006 <sup>b</sup>	2.52 $\pm$ 0.03 <sup>b</sup>	1.35 $\pm$ 0.03 <sup>a</sup>
F1	0.108 $\pm$ 0.009 <sup>b</sup>	2.24 $\pm$ 0.05 <sup>c</sup>	0.56 $\pm$ 0.06 <sup>c</sup>
F2	0.111 $\pm$ 0.001 <sup>b</sup>	2.23 $\pm$ 0.04 <sup>c</sup>	0.90 $\pm$ 0.03 <sup>b</sup>
F3	0.141 $\pm$ 0.001 <sup>a</sup>	3.71 $\pm$ 0.07 <sup>a</sup>	1.39 $\pm$ 0.07 <sup>a</sup>

F0 represents edible film casted from chitosan without gallic acid; F1 represents edible film casted from chitosan with 0.5 g/100 g gallic acid (w/v); F2 represents edible film casted from chitosan with 1.0 g/100 g gallic acid (w/v); F3 represents edible film casted from chitosan with 1.5 g/100 g gallic acid (w/v). Superscripts in same column with different letters indicate significant differences ( $p < 0.05$ )

**CHAPTER 4 EFFECTS OF CHITOSAN-ESSENTIAL OIL COATINGS ON SAFETY  
AND QUALITY OF FRESH BLUEBERRIES**

Xiuxiu Sun <sup>a</sup>, Jan Narciso <sup>b</sup>, Zhe Wang <sup>b</sup>, Christopher Ference <sup>b</sup>,

Jinhe Bai <sup>b,\*</sup>, Kequan Zhou <sup>a,\*</sup>

<sup>a</sup> Department of Nutrition and Food Science, Wayne State University, Detroit, MI 48202

<sup>b</sup> USDA, ARS, USHRL, 2001 S. Rock Rd, Ft. Pierce, FL 34945

\* Corresponding author: Jinhe.bai@ars.usda.gov (772-462-5880) and

kzhou@wayne.edu (313-577-3444)

**KEY WORDS:** chitosan coating; essential oil; blueberry; antimicrobial activity;

postharvest

**Published in: Journal of Food Science 79 (2014), M955-M960**

## Abstract

Chitosan coating plus different essential oils was developed and applied to fresh blueberries, in order to find more natural treatments to preserve fresh fruit quality and safety during postharvest storage. Studies were first performed *in vitro* where wild-type *Escherichia coli* and *Penicillium digitatum* were grown in suitable media, and then subjected to six essential oils. Three compounds, carvacrol (CAR), cinnamaldehyde (CIN) and trans-cinnamaldehyde (ECIN) had high antimicrobial capacity and were selected for an *in vivo* study for postharvest storage of blueberries. The selected essential oils, 0.5% each, were added into a chitosan solution and coated on fresh blueberries. After storage at 5, 10 and 20 °C for various days, fruit firmness and microbial populations were evaluated. The chitosan coating substantially decreased bacteria and yeasts/molds on the fruit, and all three essential oils added to the antimicrobial activities. Further dosage experiments showed that the antimicrobial activity remained even when lowering CAR concentration to 0.1% and ECIN to 0.2%. Chitosan, CAR and ECIN also maintained fruit firmness. Our results suggest that chitosan coatings containing essential oils are effective in extending the shelf life of fresh blueberries.

**Practical Application:** Blueberries are high-value fruit with strong antioxidant capacity and other health-promoting benefits. However, microbial food safety is an increasing concern, and decay and softening limits their storability. A combination of  $\geq 0.1\%$  CAR or  $\geq 0.2\%$  ECIN with a chitosan coating effectively reduced softening of fresh berries and decay by inhibiting microbial growth.

## Introduction

Blueberries have become a leading berry crop in the United States, and their high antioxidant potential and high oxygen radical scavenging capacity have been receiving increased attention (Ortiz and others 2013). Blueberries are rich in flavonoids and phenolic acids, which exhibit a wide range of biological effects, including antioxidant and anticarcinogenic properties (Zheng and Wang 2003), and a protective effect against chronic diseases, especially cardiovascular diseases (Fracassetti and others 2013). However, blueberries are very perishable after harvest. Fresh blueberries typically have a shelf life of 1-8 wk depending on the genomic background, growth region, harvest maturity, harvest method, presence of disease, and storage conditions (Almenar and others 2010). Physical destruction caused by loss of firmness and microbial decay are two major detrimental factors in postharvest storage and marketing of blueberries (Connor and others 2002; Li and others 2011). Pre- and post-harvest applications of fungicides have been widely used in commercial practice in addition to low temperature storage (Gallo and others 2007; Iqbal and others 2010). Nevertheless, there is a great need to pursue natural preservatives which will provide environmentally friendly treatments to maintain fruit quality and are safe for human consumption.

Microbial safety of fresh blueberries is an increasing concern with any possible recall or outbreaks negatively affecting the entire industry. An outbreak of hepatitis A, an RNA virus associated with consumption of raw blueberries, was investigated in New Zealand in which the blueberries were likely contaminated from polluted water or by infected food handlers (Calder and others 2003). Similarly, an outbreak of six cases of illness due to *Salmonella* Newport on blueberries occurred in Minnesota in 2010 (Miller

and others 2013). Because of the foodborne illnesses caused by blueberries, retailers of blueberries are now beginning to test for foodborne pathogens, including *Listeria monocytogenes*, *Escherichia coli* and *Salmonella*, as well as yeasts and molds, such as *Colletotrichum* and *Penicillium* (Popa and others 2007).

Many new chemical and physical processes have been tested on fruit and vegetables, including blueberries for improving their quality and safety. Natural preservatives, such as chitosan and essential oils, are promising approaches among the treatments. Chitosan is mainly found in the exoskeletons of crustaceans and is classified as a “generally recognized as safe” (GRAS) material. Chitosan is a versatile biopolymer which exhibits antimicrobial activity against a range of foodborne microorganisms and consequently has attracted attention as a potential preservative (Ganan and others 2009). Chitosan has a broad range of applications in the food industry (Gao and others 2013), one of which is its application as an edible coating material. The chitosan coating creates a semi-permeable barrier that can reduce water loss and alter the natural exchange of gases between the fruit and the external atmosphere, thereby reducing respiration, slowing senescence in fruit and vegetables, and inhibiting microbial decay (Gao and others 2013). The mechanical properties of the chitosan polymer also contribute to the protection of fruit from physical damage. Chitosan coatings have been found to be effective in microbial control and in preserving quality in many vegetables and fruits such as table grapes and mushrooms (Gao and others 2013).

Essential oils are natural volatile substances extracted from plants. Most of them consist of a mixture of terpenoids and other aromatic and aliphatic constituents (Bakkali



and others 2008). It has long been recognized that many plant essential oils exhibit antioxidant and antimicrobial properties (Wang and others 2008b), and some components in essential oils have been isolated and identified as the putative factors involved with observed antimicrobial activity (Wallace 2005). The *in vitro* antimicrobial properties of essential oils are known to be effective against a wide range of foodborne fungi and bacteria (Saidi and others 2012). For instance, trans-cinnamaldehyde (ECIN), carvacrol (CAR), and eugenol (EUG) have been shown to exhibit strong antimicrobial activity against *Salmonella* Enteritidis and *Campylobacter jejuni* in chicken cecal contents (Johny and others 2010). Cinnamaldehyde (CIN) and EUG showed strong inhibitory activity against pathogenic and spoilage bacteria and yeast in an *in vitro* study (Sanla-Ead and others 2012). The inhibition effects of benzaldehyde (BEN) and its derivatives against different types of microorganisms was explored, and the minimum inhibitory concentration (MIC) ranged from 12.5 mg/mL to 25 mg/mL (Alamri and others 2012). Eucalyptol (EUC) inhibited mycelial growth of all fungal species (Morcia and others 2012). However, the use of essential oils in food preservation is limited because of the cost and other drawbacks, such as their intense aroma and potential toxicity. An interesting approach is to combine reduced doses of essential oils together with chitosan coatings. Some edible coatings containing both chitosan and essential oil have proven to be effective at enhancing the quality and extending the shelf-life of grapes and mushrooms (Jiang and others 2012; dos Santos and others 2012). To our knowledge, this is the first study to show the effect of chitosan composite coatings with ECIN or CAR on the postharvest quality of fresh fruit. The aim of this study is to

elucidate the potential of chitosan coatings with or without essential oils on the extension of the storage life of fresh blueberries.

## **Materials and Methods**

### **Plant, microbial and chemical materials**

Southern highbush blueberries *Vaccinium virgatum* were purchased from a local store and used immediately after purchase or within 2 d storage at 5 °C. *Escherichia coli* was a wild-type culture isolated from citrus fruit as described by Narciso et.al (Narciso and others 2012). *Penicillium digitatum* Link was also isolated from citrus fruit (Narciso 2009). Medium molecular weight (190–310 kDa) chitosan (deacetylation degree 75-85%) and glacial acetic acid were obtained from Sigma-Aldrich Co (St. Louis, Mo., U.S.A.). Food grade glycerol, as a plasticizing agent, Tween-20, as an emulsifier and essential oils, trans-cinnamaldehyde (ECIN), carvacrol (CAR), cinnamaldehyde (CIN), benzaldehyde (BEN), eugenol (EUG), and eucalyptol (EUC) as antimicrobial agents, were purchased from Fisher Scientific Inc. (Pittsburgh, Penn., U.S.A.).

### ***In vitro* antimicrobial activity**

Antimicrobial capacity of six essential oils: ECIN, CAR, CIN, BEN, EUG, and EUC against *E. coli* and *P. digitatum* were determined by chamber and agar diffusion methods. The chamber method was performed as described by Narciso (Narciso 2009) with a slight modification. Briefly, a 7 cm diameter filter paper was laid on a diameter 9 cm and height 5 cm glass plate, and four 1 cm<sup>3</sup> cubes of sponge were evenly placed on the paper. Agar plugs, obtained by using a 5.8 mm ID cork borer, of E.C. agar (ECA)

for *E. coli* or potato dextrose agar (PDA) for *P. digitatum* were placed on to the top of the sponge, and then microbes were inoculated. The spore or cell concentration was  $10^5$  CFU/mL and inoculation volume was 5  $\mu$ L per agar plug. A fifth sponge, without agar plug, was placed in the center of the chamber to support a stainless steel insect pin with a small filter paper disc (10.5 mm, Ace Glass Co., Inc., New York, N.Y., U.S.A.) on the top. Essential oil (15.9  $\mu$ L) was then added into the filter disc, which made the final concentration in the chamber being 50 mg/L. Control chambers had 15.9  $\mu$ L of sterile water on the filter disc. The chambers were gas tight sealed and incubated at 30 °C for 1 d for *E. coli* and at 25 °C for 3 d for *P. digitatum*. To evaluate the antibacterial activity, the plugs were transferred onto a full agar plate for a further 1 d of incubation. Antimicrobial activity was scored with scale of 0 = no inhibition; 1 = slight inhibition; 2 = moderate inhibition; 3 = strong inhibition – very slight growth; and 4 = complete inhibition. All experiments were performed in triplicate and each replicate contained 4 sponge-colonies.

For agar diffusion method (zone of inhibition), a 0.1 mL of *E. coli* suspension ( $\approx 10^5$  CFU/mL) or 0.25 mL of *P. digitatum* spore suspension ( $\approx 10^5$  CFU/mL) was spread with a sterile glass spreader on the surface of an ECA or PDA plate, respectively. A 6-mm diameter sterile filter disc impregnated with either 1.0  $\mu$ L or 2.5  $\mu$ L of essential oil for *E. coli*, and either 0.25  $\mu$ L or 0.5  $\mu$ L for *P. digitatum*, was then deposited on the surface of the plate. Filter discs impregnated with same amount of sterile water were used as the control. An inhibition zone size was measured after incubating *E. coli* at 30 °C for 1 d and *P. digitatum* at 25 °C for 3 d with a digital caliper (General Tools Mfg. Co. LLC, New York, N.Y., U.S.A.).

### ***In vivo* study by using fresh blueberries**

Three essential oils, ECIN, CIN or CAR selected from the *in vitro* experiments were incorporated into chitosan coatings which were applied to fresh blueberries to determine their effects on yeasts/molds, total microbial count, and fruit firmness. The treated berries were packaged in one-pound perforated clamshells (polyethylene terephthalate made (PET #1), Packaging Plus, Yakima, Wash., U.S.A.) and stored in various conditions. The first *in vivo* experiment used a single dosage, 0.5% essential oil for each treatment, and fruit were stored at 5, 10 and 20 °C for 14 d, 8 d and 4 d, respectively. In the second *in vivo* experiment, an efficacy test was run for different ECIN and CAR concentrations at 10 °C for 7 d. All treatments contained three replicates.

A 1% (w/v) chitosan coating solution was prepared by slowly adding chitosan powder into 1% aqueous acetic acid with 0.75% glycerol (v/v) aqueous solution under gentle stirring. The mixture was homogenized by polytron (PT 10-35, Kinematica AG, Littau, Switzerland) for 90 s at 13,500 rpm, and then stored overnight at room temperature (22 °C). Various amounts of essential oil (CIN, ECIN, or CAR) and Tween-20 (0.25%, v/v) were added to the chitosan solution. The final coating mixtures were homogenized under 21,600 rpm for 60 s. The final formulations of coating were: 1% chitosan, 1% acetic acid, 0.75% glycerol, 0.25% Tween-20 and 0.1-0.5% essential oils. Water containing 1% acetic acid was used as the control.

Defect free blueberries were dipped into the given coating mixture for 30 s. Afterwards, the coated berries were drained and spread out onto an elevated screen

and allowed to dry at room temperature for 2 h, and then fruit were stored in commercial clamshells under different storage conditions. For the *in vivo* experiment 1, essential oil content was 0.5%. A total of 93 clamshells of berries were used, including 5 treatments (water control, chitosan coating alone, and chitosan coating plus ECIN, CAR or CIN) x 3 storage temperatures (5 °, 10 ° and 20 °C) x 2 storage times per temperature x 3 replicates + 3 clamshells for d 0 measurements. Each clamshell (replicate) contained approximately 180 g of berries. For the *in vivo* experiment 2, a total 75 clamshells were used, including 12 treatments (water control, chitosan coating alone, and chitosan coating plus 0.1, 0.2, 0.3, 0.4 and 0.5% ECIN or CAR) x 2 storage times (d 4 and d 7) x 3 replicates + 3 initial samples for d 0. Each clamshell contained approximately 160 g of berries. The storage temperature was 10 °C.

### **Measurement of microbial populations on fruit**

Total aerobic mesophilic microorganism, yeast and mold populations in fruits were evaluated periodically throughout storage. Under sterile conditions, twenty fruit from each replicate (clamshell) were agitated for 1 h in 99 mL of 0.01 M sterile potassium phosphate buffer (pH 7.2) in a sterile sampling bag (Fisher Scientific, Pittsburgh, Penn., U.S.A.) on an orbital shaker (Innova 2100, New Brunswick Scientific, New Brunswick, N.J., U.S.A.). Serial dilutions of fruit homogenates were spread on plate count agar (PCA), for enumerated mesophilic aerobic bacteria and PDA, for yeasts and molds using an Eddy Jet Spiral Plater (Neutec Group Inc., Farmingdale, N.Y., U.S.A.). PCA and PDA plates were incubated at 30 °C for 1 d and at 25 °C for 3 d,

respectively, and the results were read on a ProtoCOL colony counter (Synoptics, Ltd., Cambridge, UK). All tests were run in triplicate.

### **Measurement of berry firmness during storage**

Blueberry firmness was measured by a FirmTech 2 Fruit Firmness Tester (Bioworks Inc, Kans., U.S.A.), and expressed as  $N\ m^{-1}$ . Twenty blueberries were used per replicate.

### **Statistical analyses**

All experiments were replicated at least three times. Data were analyzed using analysis of variance (ANOVA) with SPSS version 17.0 software (Experian QAS, Boston, Mass., U.S.A.). Mean separation was determined by Duncan's multiple range test. Significance was defined at  $p < 0.05$ .

## **Results and Discussion**

### **Comparison of antimicrobial activity of six essential oils under *in vitro* conditions**

Antimicrobial activities of six essential oils, CIN, CAR, BEM, ECIN, EUG and EUC on *E.coli* and *P. digitatum* were evaluated using two *in vitro* methods: vapor-based chamber method, and direct liquid contact-based inhibition zone method. The vapor-based test results showed that the essential oils exhibited remarkably different antimicrobial activities to *E.coli* and *P. digitatum* (Table 4-1). All essential oils exhibited a certain degree of antimicrobial activities on *E. coli*, with ECIN completely inhibiting the growth of all *E. coli*, but BEN and EUC had the weakest bactericidal activity against *E.*

*coli* (Table 4-1). Activities of CIN, CAR and EUG strongly, but not completely, controlled the growth of *E. coli* (Table 4-1). Antimicrobial activities to *P. digitatum* activities of the essential oils were parallel to the activities to *E. coli*, but the effects were weaker (Table 4-1). None of the selected essential oils were able to completely inhibit the growth of *P. digitatum*. BEN and EUC, the two weakest oils to *E. coli*, showed no inhibition on the growth of *P. digitatum* (Table 4-1). The agar diffusion method was conducted to further verify the antimicrobial activity of these essential oils at two levels and the results are shown in Table 4-2. Four out of six essential oils, CIN, CAR, ECIN and EUG, showed antimicrobial activity against both *E. coli* and *P. digitatum* at various levels, however, BEN and EUC did not show antimicrobial activity to either organism (Table 4-2), while CAR, CIN and ECIN exhibited the strongest antimicrobial activity to both *E. coli* and *P. digitatum*.

Studies have shown that essential oils are able to disrupt and penetrate the lipid structure of the cell membrane and the mitochondrial membrane, leading to the disruption of the cell membrane, cytoplasmic leakage, cell lysis and eventually cell death (Kalemba and Kunicka 2003). It has been suggested that the antimicrobial activity of essential oils may be related to their involvement with enzymatic reactions which regulate wall synthesis (Soylu and others 2010). The lipophilic properties of essential oil components might have also aided its ability to penetrate the plasma membrane (Pauli and Knobloch 1987). The observations made with light microscopy are in accordance with previous studies in which essential oils of aromatic plants caused morphological alterations on the fungal hyphae (Soylu and others 2010). CAR is a type of phenolic compound which showed strong activity due to the acidic nature of the hydroxyl groups

forming a hydrogen bond with an enzyme active center in the microorganisms (Pauli and Knobloch 1987), and showed fungistatic activity against *P. citrophthora* (Camele and others 2012). Our results showed that CAR also had substantial antimicrobial activities against *E. coli* and *P. digitatum* (Table 4-1 and 4-2). CIN occurs naturally in the bark of cinnamon trees and other species of the genus *Cinnamomum* such as camphor and cassia (Wang and others 2008b). In a previous study, the antibacterial activities of CIN, EUG and CAR against *E. coli* were compared and the MIC of CIN and CAR was 400 mg/L, however, MIC of EUG was 1600 mg/L, indicating that EUG has weaker antimicrobial activity (Pei and others 2009); the trend of their antimicrobial activities was in agreement with our results generated by the agar diffusion method (Table 4-2). EUC is another weak microbial inhibitor which showed inhibition against the storage fungi *Aspergillus flavus* Link and *A. parasiticus* Speare at a dosage of up to 1349 mg/L (Vilela and others 2009), which were further confirmed by another study showing that the fungi were not completely inhibited by EUC at 918 mg/L (Shukla and others 2012).

Collectively, our results and previous reports agreed that CAR, CIN and ECIN strongly inhibited the growth of bacteria and yeasts/molds, but EUG, BEN and EUC, on the other hand, had little antimicrobial activity (Table 4-1 and 4-2). Therefore, we selected CAR, CIN and ECIN for our further research to apply them in a coating to blueberry fruit to maintain quality and safety.

### **Antimicrobial effect of chitosan coating incorporated with essential oils on fresh blueberries**



In the first *in vivo* study, we examined the antimicrobial effects of chitosan coatings incorporated with one of the following three essential oils, CAR, CIN and ECIN. The essential oil dose was 0.5%. As shown in Table 4-3, chitosan alone was able to completely inhibit the growth of bacteria and yeasts/molds on fresh blueberries stored at 5 °C during an extended period of storage time (14 d). However, when the blueberries were stored at 10 °C, all three chitosan-essential oil coatings completely inhibited bacteria and yeasts/molds for the first 5 d, while the chitosan alone showed some growth of both bacteria and yeasts/molds at 1.29 and 1.34 log CFU/g, respectively, during that period. However, CFUs were significantly reduced by more than 3 logs as compared to the untreated control (Table 4-3). When the storage time was extended to 8 d (at 10 °C), antimicrobial efficiency of chitosan was reduced, and the additional effects from essential oils completely disappeared (Table 4-3). When fruit were stored at 20 °C, the microbial growth was remarkably hastened. At d 4, the population of bacteria and yeasts/molds were more than 5 logs in the control (Table 4-3). Generally, a 2-log reduction was seen by chitosan treatment alone, but there is little additional effect from any essential oil at the highest storage temperature (Table 4-3). These results suggest that the chitosan coating substantially reduced microbial populations in stored blueberry fruit regardless of storage temperature and duration. Incorporating essential oils into a chitosan coating may or may not contribute additional antimicrobial activities against bacteria and yeasts/molds in fruit, depending on storage time and temperature.

To determine the relationship between essential oil dosage and antimicrobial activity, five dosages of CAR or ECIN, ranging from 0.1 to 0.5%, were incorporated into chitosan coating mixtures. Chitosan alone slightly inhibited the growth of mesophilic

and yeasts/molds at d 7, and all CAR treatments, regardless of the concentration, further enhanced the inhibition (Fig. 4-1a and 4-1b). For mesophilics population,  $\geq 0.2\%$  CAR was more effective than 0.1%, however, for yeast/mold populations there was no clear dosage response (Fig. 4-1a and 4-1b). Responses of microorganisms to ECIN were more dosage dependent in comparison with CAR. ECIN at 0.1% did not show antimicrobial activity, treatments at 0.2-0.4% significantly reduced microbial populations although there was no dosage response within the dosage range, and at 0.5% showed remarkably higher antimicrobial activities to both bacteria and yeasts/molds (Fig. 4-1c and 4-1d).

A recent study demonstrated that the antimicrobial effect of chitosan is highly dependent on the types of microorganisms, being mainly effective against bacteria and certain molds (Elsabee and Abdou 2013b). Biodegradable chitosan coatings containing bergamot oil showed significant antimicrobial activity on table grapes (Sanchez-Gonzalez and others 2011). Chitosan films with 0.46% and 0.64% CAR had strong antimicrobial effect to *E. coli*, *Bacillus subtilis* and *Listeria innocua* (Kurek and others 2013). A previous study showed that ground beef patties containing 0.15% or 0.3% of ECIN significantly reduced *E. coli* O157:H7 counts, by  $> 5.0$  logs, relative to the reduction in controls (Amalaradjou and others 2010).

The results suggest that essential oils may enhance antimicrobial activities of chitosan coatings and it is important to select appropriate essential oils and determine the appropriate concentration to be incorporated into chitosan. In our experiment, the chitosan-0.5% ECIN mixture was the most effective treatment and 0.1-0.5% CAR and 0.2-0.4% ECIN also reduced populations of bacteria and yeasts/molds.

### **Fruit firmness during storage**

Figure 4-2 shows the firmness of blueberries treated with chitosan coating or chitosan-essential oil mixtures. The firmness of uncoated blueberries declined from 214.1 to 184.5 N m<sup>-1</sup> after 7 d cold storage (Fig. 4-2). Chitosan coatings reduced loss of firmness and application of the coating incorporated with  $\geq 0.1\%$  CAR or  $\geq 0.2\%$  ECIN further protected fruit from softening (Fig. 4-2). The results indicate that the firmness of the blueberries is greatly affected by the coatings and CAR and ECIN compounds.

Firmness is one of the most critical quality attributes influencing consumer appeal and marketing of fresh fruit. Blueberries normally soften during the postharvest chain which consequently decreases fruit shelf life and reduces fruit market value (Duan and others 2011). Previous studies reported that edible coatings were able to delay loss of firmness during postharvest cold storage for blueberries (Duan and others 2011) and strawberries (Mali and Grossmann 2003). In addition, the chitoan-CAR/ECIN inhibition of the growth of microorganisms may contribute to firmness maintenance of blueberries (Jiang and others 2012).

Some studies demonstrated that blueberry moisture loss strongly coincided with decreased firmness (Angeletti and others 2010). Moisture loss of fruit has been suggested to induce postharvest softening in blueberries due to reduced turgor (Paniagua and others 2013). Cell wall modification caused by the hydrolysis of starch to sugar and the degradation of pectin was also reported to relate to postharvest firmness changes in blueberries (Duan and others 2011). It was thought that pectate lyase (PEL) was strictly a microbial enzyme, however, suppression of PEL gene expression in

transgenic strawberries was reported to result in substantially firmer fruits and reduced cell wall swelling (Jimenez-Bermudez and others 2002). Essential oils, as concentrated hydrophobic liquids, have been incorporated into chitosan coatings to improve their moisture barrier properties (Perdones and others 2012). The results from this study suggest that chitosan-CAR/ECIN coatings maintained fruit firmness through at least two possible mechanisms: maintenance of high turgor by reducing water loss and decrease of pectin degradation by reducing microbial populations on the fruit. Chitosan coating most likely prevented fruit water loss, and the lipophilic property of the essential oils may have further reduced the water permeability of the coating. The antimicrobial activity of chitosan, CAR and ECIN decreased microbial populations on the fruit, thus reducing pectin degradation caused by microorganisms.

## **Conclusion**

In summary, the present study showed that chitosan coatings incorporated with certain essential oils (CAR, ECIN and CIN) may be an effective alternative for fresh blueberry preservation. The coatings maintained fruit firmness and reduced microbial growth on the fresh fruit during storage. CAR at  $\geq 0.1\%$  or ECIN at  $\geq 0.2\%$  incorporated with chitosan coatings improved antimicrobial activity and all chitosan treatments decreased fruit firmness during storage. Chitosan-essential oil coatings can be used for preserving and extending the shelf life of blueberries and other perishable fruits.

**Table 4-1. Antimicrobial activity of CIN, CAR, BEN, ECIN, EUG and EUC on the growth of *E.coli* and *P. digitatum* determined by vapor-based test**

Bacteria	Antimicrobial activity scale						
	Control	CIN	CAR	BEN	ECIN	EUG	EUC
<i>E.coli</i>	0 <sup>d</sup>	3 <sup>b</sup>	3 <sup>b</sup>	2 <sup>c</sup>	4 <sup>a</sup>	3 <sup>b</sup>	2 <sup>c</sup>
<i>P. digitatum</i>	0 <sup>c</sup>	3 <sup>a</sup>	3 <sup>a</sup>	0 <sup>c</sup>	3 <sup>a</sup>	2 <sup>b</sup>	0 <sup>c</sup>

The scales from 0 to 4 represent the antimicrobial activity from non-inhibition to complete inhibition: 0 = no inhibition; 1 = slight inhibition; 2 = moderate inhibition; 3 = strong inhibition – very slight growth; and 4 = complete inhibition. Superscripts in same row with different letters indicate significant differences ( $n = 3$ ;  $p < 0.05$ ).

CIN: cinnamaldehyde; CAR: carvacrol; BEN: benzaldehyde; ECIN: trans-cinnamaldehyde; EUG: eugenol; EUC: eucalyptol.

**Table 4-2. Inhibition activity of CIN, CAR, BEN, ECIN, EUG and EUC on the growth of *E.coli* and *P. digitatum* tested by direct liquid contact-based inhibition zone method. The diameter of inhibition zone was measured and expressed in mm.**

Bacteria	Volume	CON	CIN	CAR	BEN	ECIN	EUG	EUC
<i>E.coli</i>	1.0 $\mu$ L	0 <sup>d</sup>	24.0 $\pm$ 1.2 <sup>b</sup>	25.9 $\pm$ 1.4 <sup>a</sup>	0 <sup>d</sup>	24.3 $\pm$ 0.8 <sup>b</sup>	8.9 $\pm$ 0.1 <sup>c</sup>	0 <sup>d</sup>
	2.5 $\mu$ L	0 <sup>e</sup>	38.0 $\pm$ 0.5 <sup>b</sup>	39.9 $\pm$ 1.1 <sup>a</sup>	0 <sup>e</sup>	35.3 $\pm$ 2.2 <sup>c</sup>	16.1 $\pm$ 0.3 <sup>d</sup>	0 <sup>e</sup>
<i>P. digitatum</i>	0.25 $\mu$ L	0 <sup>d</sup>	39.2 $\pm$ 1.9 <sup>a</sup>	21.8 $\pm$ 0.9 <sup>b</sup>	0 <sup>d</sup>	38.3 $\pm$ 3.3 <sup>a</sup>	7.1 $\pm$ 0.2 <sup>c</sup>	0 <sup>d</sup>
	0.5 $\mu$ L	0 <sup>e</sup>	52.9 $\pm$ 0.7 <sup>a</sup>	29.9 $\pm$ 0.6 <sup>c</sup>	0 <sup>e</sup>	44.6 $\pm$ 1.7 <sup>b</sup>	8.9 $\pm$ 0.1 <sup>d</sup>	0 <sup>e</sup>

Superscripts in same row with different letters indicate significant differences ( $n = 3$ ;  $p < 0.05$ ). CON: control; CIN: cinnamaldehyde; CAR: carvacrol; BEN: benzaldehyde; ECIN: trans-cinnamaldehyde; EUG: eugenol; EUC: eucalyptol.

**Table 4-3. Effects of edible coatings enriched with essential oils on antimicrobial activities of fresh blueberries at 0.5% under different storage conditions, expressed in log CFU/g.**

	Storage conditions													
	5 °C						10 °C				20 °C			
	0d		7d		14d		5d		8d		1d		4d	
	BP	YMP	BP	YMP	BP	YMP	BP	YMP	BP	YMP	BP	YMP	BP	YMP
CON	4.22 <sup>a</sup>	4.16 <sup>a</sup>	3.19 <sup>a</sup>	3.17 <sup>a</sup>	6.10 <sup>a</sup>	3.56 <sup>a</sup>	4.34 <sup>a</sup>	4.48 <sup>a</sup>	5.49 <sup>a</sup>	5.42 <sup>a</sup>	4.22 <sup>a</sup>	4.17 <sup>a</sup>	5.48 <sup>a</sup>	5.49 <sup>a</sup>
CS	4.22 <sup>a</sup>	4.16 <sup>a</sup>	0 <sup>b</sup>	0 <sup>b</sup>	0 <sup>b</sup>	0 <sup>b</sup>	1.29 <sup>b</sup>	1.34 <sup>b</sup>	4.20 <sup>ab</sup>	4.21 <sup>ab</sup>	0 <sup>b</sup>	0 <sup>b</sup>	3.31 <sup>b</sup>	3.34 <sup>bc</sup>
ECIN	4.22 <sup>a</sup>	4.16 <sup>a</sup>	0 <sup>b</sup>	0 <sup>b</sup>	0 <sup>b</sup>	0 <sup>b</sup>	0 <sup>b</sup>	0 <sup>b</sup>	4.56 <sup>ab</sup>	4.54 <sup>ab</sup>	0 <sup>b</sup>	0 <sup>b</sup>	3.47 <sup>b</sup>	3.73 <sup>b</sup>
CAR	4.22 <sup>a</sup>	4.16 <sup>a</sup>	0 <sup>b</sup>	0 <sup>b</sup>	0 <sup>b</sup>	0 <sup>b</sup>	0 <sup>b</sup>	0 <sup>b</sup>	4.18 <sup>ab</sup>	4.22 <sup>ab</sup>	0 <sup>b</sup>	0 <sup>b</sup>	3.00 <sup>b</sup>	2.81 <sup>bc</sup>
CIN	4.22 <sup>a</sup>	4.16 <sup>a</sup>	0 <sup>b</sup>	0 <sup>b</sup>	0 <sup>b</sup>	0 <sup>b</sup>	0 <sup>b</sup>	0 <sup>b</sup>	3.78 <sup>b</sup>	4.06 <sup>b</sup>	0 <sup>b</sup>	0 <sup>b</sup>	2.65 <sup>b</sup>	2.68 <sup>c</sup>

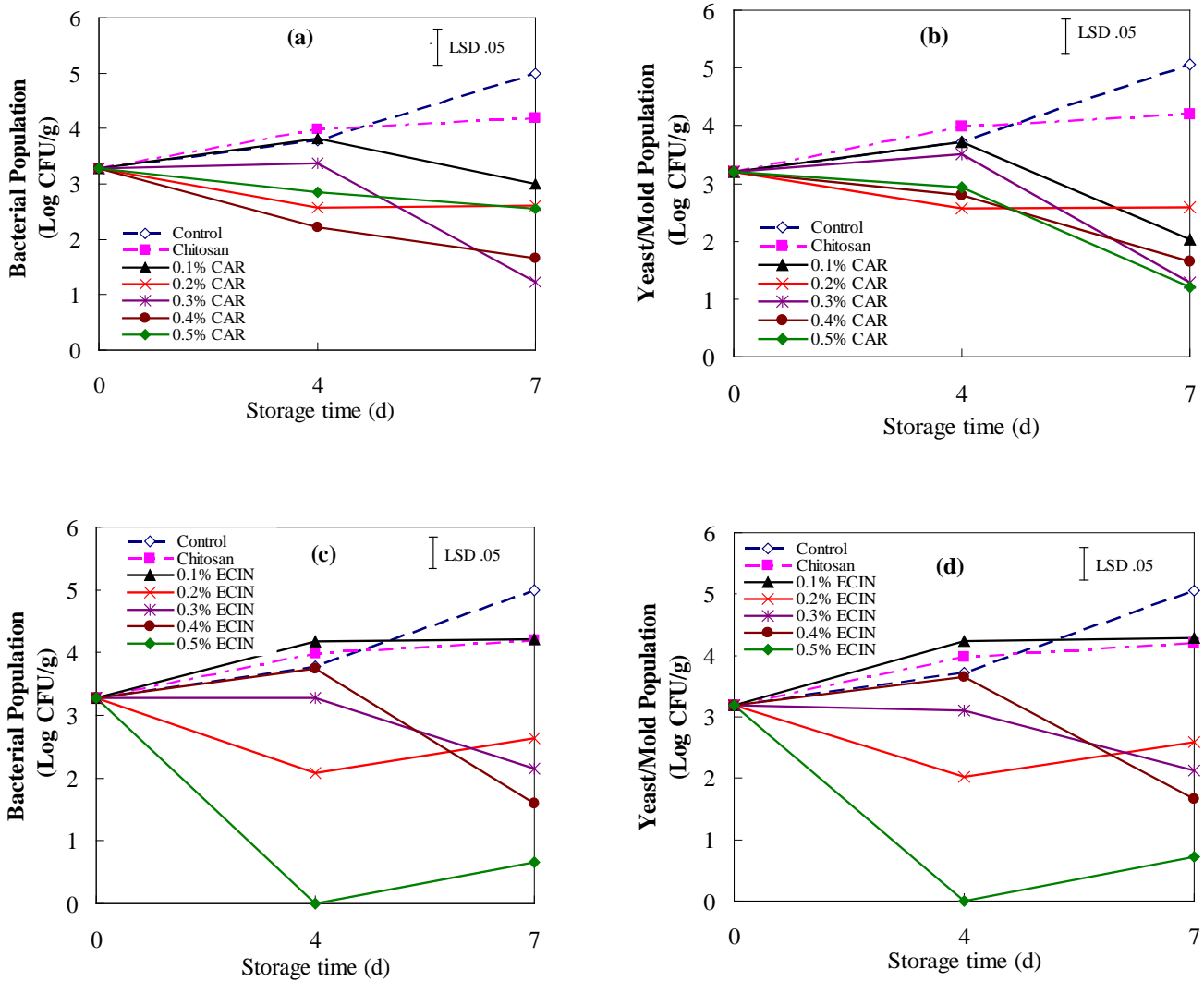
Superscripts in same column with different letters indicate significant differences ( $n = 3$ ;  $p < 0.05$ ).

BP: population of mesophilic aerobic bacteria; YMP: population of yeasts and molds.

CON: control; CS: chitosan; CIN: cinnamaldehyde; CAR: carvacrol; BEN: benzaldehyde;

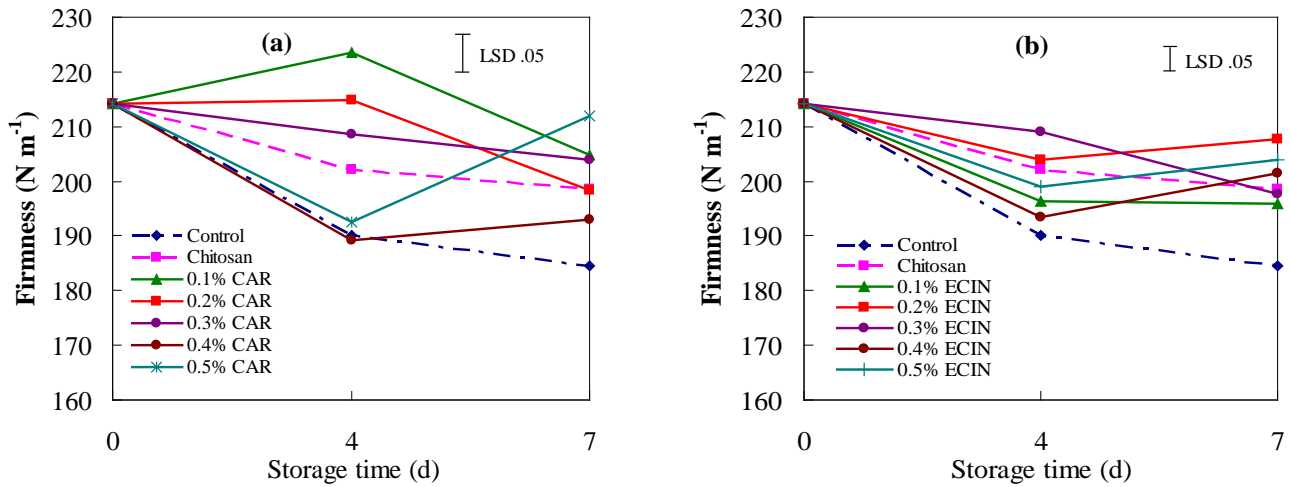
ECIN: trans-cinnamaldehyde; EUG: eugenol; EUC: eucalyptol.

Figure 4-1. Effects of chitosan coating combined with CAR or ECIN on enumerated mesophilic aerobic bacteria (a and c) and yeasts and molds (b and d) of fresh blueberries during storage at 10 °C for up to 7 d. (CAR: carvacrol; ECIN: trans-cinnamaldehyde; n = 3;  $p < 0.05$ )





**Figure 4-2. Effects of edible coatings enriched with CAR (a) or ECIN (b) on firmness of fresh blueberries during storage at 10 °C for up to 7 d, expressed in  $N\ m^{-1}$ . (CAR: carvacrol; ECIN: trans-cinnamaldehyde;  $n = 3$ ;  $p < 0.05$ )**



## CHAPTER 5 ANTIMICROBIAL ACTIVITY OF CONTROLLED-RELEASE CHLORINE DIOXIDE GAS ON FRESH BLUEBERRIES

Xiuxiu Sun <sup>a,b</sup>, Jinhe Bai <sup>b</sup>, Christopher Ference <sup>b</sup>, Zhe Wang <sup>b</sup>, Yifan Zhang <sup>a</sup>, Jan Narciso <sup>b,\*</sup>, Kequan Zhou <sup>a,\*</sup>

<sup>a</sup> Department of Nutrition and Food Science, Wayne State University, Detroit, MI 48202

<sup>b</sup> USDA, ARS, USHRL, 2001 S. Rock Rd, Ft. Pierce, FL 34945

\* Corresponding author: jan.narciso@ars.usda.gov (772-801-1155) and kzhou@wayne.edu (313-577-3444)

**KEY WORDS:** chlorine dioxide; blueberry; antimicrobial activity; postharvest; controlled-release

**Published in: Journal of Food Protection 77 (2014), 1127-1132**

## Abstract

The effect of chlorine dioxide ( $\text{ClO}_2$ ) gas on the safety and quality of blueberries was studied. *In vitro* studies revealed that both  $\text{ClO}_2$  gas fumigation and  $\text{ClO}_2$  water direct contact-killed food pathogen bacterium, *Escherichia coli* and fruit decay pathogen fungus, *Colletotrichum acutatum*. *In vivo* studies were conducted using non-inoculated berries and berries inoculated with postharvest decay and foodborne pathogens. Berries were inoculated with either *E. coli* (5.2 log CFU/g) or *C. acutatum* (3.9 log CFU/g). Inoculated fruit were dried for 2 h at room temperature in a climate controlled laboratory, and packed in perforated commercial clamshells, with or without  $\text{ClO}_2$  pads, and stored at 10 °C for up to 9 days. The effects of  $\text{ClO}_2$  on microbial populations and fruit firmness were monitored during storage. In the inoculation experiment, treatment with  $\text{ClO}_2$  reduced populations of *E. coli* and *C. acutatum* by 2.2 to 3.3, and 1.3 to 2.0 log CFU/g, respectively. For the non-inoculated blueberries, initial total aerobic bacteria count (TBC) and yeasts/molds count (YMC) was 4.2 and 4.1 log CFU/g, respectively.  $\text{ClO}_2$  treatment reduced TBC and YMC by 1.5 to 1.8, and 1.3 to 1.7 log CFU/g, respectively. The firmness of both inoculated and non-inoculated blueberries was maintained by  $\text{ClO}_2$  treatment. Thus, controlled-release  $\text{ClO}_2$  gas fumigation technology shows promise as an effective and practical antimicrobial agent in commercial clamshell packaging in blueberry and other fruits.

## Introduction

Eating more fruits and vegetables in a balanced diet may help reduce the risk of many diseases, including heart disease, high blood pressure and specific types of cancers (Zheng and Wang 2003). However, there are a number of foodborne microbial pathogens associated with the consumption of fresh fruits and vegetables that can cause illness or even death among consumers who eat contaminated produces (Beuchat 2002). Pathogen outbreaks have been reported, in many fruits and vegetables such as, *Escherichia coli* O157:H7 in grapes, tomatoes and strawberries (Mahmoud and others 2007). Postbloom fruit drop caused by *Colletotrichum acutatum* has been reported in 2002 (Theodoro and others 2004) . Any foodborne outbreak damages the entire fresh produce industry for a long period of time (Song and others 2011), therefore, appropriate postharvest treatment is essential to prevent and control foodborne pathogens in fresh blueberries.

Microbial contamination also causes postharvest decay of fresh fruits and vegetables (Chen and Zhu 2011b). Postharvest losses of fresh fruits and vegetables are estimated to be about 20% in the United States (Lipton and others 1999). *Colletotrichum acutatum* is one of the major pathogens of fruit crops, causing significant economic losses of subtropical and tropical fruits worldwide (Vichova and others 2013). It can affect most parts of the plant, from the roots to the leaves, blossoms, twigs, and fruit, causing diseases, such as crown root rot, defoliation, blossom blight, and fruit rot (Schilder and others 2013). Other microorganisms cause decay, such as anthracnose, gray mold rot, and *Alternaria* spp., also resulting in postharvest spoilage in fresh blueberries (Miller and others 1994).

To control postharvest decay, chlorine and ozone coupled with low temperature (Crowe and others 2012), gamma irradiation (Miller and others 1994) and edible coatings (Duan and others 2011) have been investigated to preserve the quality and freshness of blueberries. Some sanitizers, such as captan (Silva and others 1987), difolatan (Austin 1976), essential oils (Wang and others 2008a), hexanal vapor (Song and others 2010), and vinegar vapor (Sholberg and others 2000) have also been studied for their effectiveness in controlling or reducing the growth of food pathogens in fresh blueberries.

Chlorine dioxide ( $\text{ClO}_2$ ), as an alternative sanitizer, was approved by the U.S. Environmental Protection Agency (EPA) and U.S. Food and Drug Administration (FDA) in the United States for postharvest application in fruits and vegetables in 2006 (Zhu and others 2013). Chlorine dioxide has 2.5 times the oxidation capacity in comparison with chlorine, a most widely used sanitizer in the produce industry (Han and others 2000). Because  $\text{ClO}_2$  is less reactive with organic compounds than chlorine, its application as a sanitizer in the food industry is of greater significance than chlorine (Wu and Kim 2007). Moreover, unlike chlorine, chlorine dioxide does not react with nitrogen-containing compounds or ammonia that results in carcinogenic byproducts (Chen and others 2011). Numerous studies have been conducted to demonstrate the bactericidal and fungicidal properties of  $\text{ClO}_2$  (Zhu and others 2013). The inactivation of *E. coli* O157:H7 on radish seeds and surface-injured green peppers was increased significantly after treatment with  $\text{ClO}_2$  (Kim and others 2010). The growth of fungi could be inhibited by  $\text{ClO}_2$  at very low concentrations (Morino and others 2007). Zhu (Zhu and others 2013) found that the ion leakage, the inhibition of key enzyme activities of

metabolic pathway, and the alteration of cell structure were critical events in inactivation of chlorine dioxide.. As ClO<sub>2</sub> gas has greater penetration ability than liquid, one particularly promising microbial reduction strategy is the use of ClO<sub>2</sub> gas as an effective disinfectant for fruit surface sanitation (Du and others 2003).

For our experiments we used manufactured ClO<sub>2</sub> impregnated crystals. These crystals undergo a controlled release of the incorporated ClO<sub>2</sub> in the presence of a water moisture rich environment. The rate of release is proportional to the degree of moisture in the surrounding atmosphere. Our preliminary experiments showed that controlled-release ClO<sub>2</sub> pads reduced decay of fresh blueberries remarkably. The objective of this research was to determine the effectiveness of controlled-release ClO<sub>2</sub> treatments in reducing the growth of bacteria and molds in both fresh non-inoculated and inoculated blueberries, as well as to observe the secondary effect of ClO<sub>2</sub> on fruit quality.

## **Materials and Methods**

### **Plant, microbial and chemical materials**

Blueberries were purchased from a local retailer and used immediately after purchase or within 2 days storage at 5 °C. The ClO<sub>2</sub> pad was made with a crystalline form of ClO<sub>2</sub> (6.4% active ingredient, Worrell Water Technologies, Charlottesville, VA) wrapped in miracloth, which allowed the ClO<sub>2</sub> vapor to release and diffuse gradually and continually (60-70% of ClO<sub>2</sub> will be released in 5 days storage under 90-95% relative humidity at 4 °C). Tween-20 was purchased from Fisher Scientific Inc. (Pittsburgh, Penn., USA).

Strains of *Escherichia coli* Wild Type and *Colletotrichum acutatum* Corda were isolated from citrus fruit surface (Narciso and others 2012) and stored at -80 °C on EC (*Escherichia coli*) agar (ECA) and potato dextrose agar (PDA) plugs in cryoprotectant (10% glycerol), respectively. The ECA plugs were re-cultured on ECA at 34 °C for a week and the bacteria were checked on Levine EMB agar. The PDA plugs were recultured on PDA at 25 °C for a week and identified by spore production.

### **Experiment settings**

Two *in vitro* and two *in vivo* experiments were conducted in April to September 2013. In the *in vitro* experiment, antimicrobial capacity of ClO<sub>2</sub> to *E. coli* and *C. acutatum* were determined by chamber and agar diffusion methods described below. The *in vivo* studies included one non-inoculation and one inoculation experiment. The common settings for the two *in vivo* experiments are: two-variable (ClO<sub>2</sub> vs. control) comparison designs were used in all experiments. Fruit were packaged in one-pound perforated commercial clamshells (polyethylene terephthalate (PET #1), Packaging Plus, Yakima, WA) with or without ClO<sub>2</sub> pads. The pads were attached on the top lids of the clamshells with a double-side sticky tape. Blueberries in the clamshells without ClO<sub>2</sub> pads were stored in a separate storage room from berries with pads to avoid crossed gas exchange. The effect of ClO<sub>2</sub> pad on antimicrobial activities and fruit firmness were measured during storage. Each treatment included three replicates.

### ***In vitro* antimicrobial activity experiments**

Two *in vitro* experiments were conducted in April 2013. The antimicrobial capacity of ClO<sub>2</sub> to *E. coli* and *C. acutatum* were determined by chamber and agar

diffusion methods described below. Chamber method was used to assess *in vitro* antimicrobial activity of ClO<sub>2</sub> gas fumigation, and performed as described by Narciso (Narciso 2009) with minor modifications. A 7 cm diameter water soaked filter paper disk was placed in a 9 cm diameter by 5 cm height glass culture chamber with four pieces of 1-cm<sup>3</sup> sponge evenly placed on the paper. Glass coverlips (#1) were placed on top of the small sponge pieces. The chamber was covered with a glass petri dish top and the chamber was sterilized. Plates of EC agar (ECA) (EC broth (Oxoid, UK) with 1.5% agar) and potato dextrose agar (PDA) (BD Difco, Sparks, MD) were prepared. Plugs of agar were removed from the agar plates with a sterile 5.8 mm ID cork borer and placed on top of the coverslip. Five microliter of a 10<sup>6</sup> suspension of either *E. coli* or *C. acutatum* was placed on the agar plugs. A fifth sponge was placed in the center of the chamber to support a stainless steel insect pin which held a small filter paper disc (diameter 1.05 cm, Ace Glass Co., Inc., NY, USA) with ClO<sub>2</sub> (15.9 mg) on the top (Fig. 1). The weight of ClO<sub>2</sub> was calculated based on the volume of the chamber to get the final concentration of 50 mg/L. The chambers were placed in zip-lock bags and incubated at 30 °C for 24 h for *E. coli* and 22 °C for 3 days for *C. acutatum*. To verify the antibacterial activity of ClO<sub>2</sub>, the incubated pieces were transferred onto full agar plates for further 24 h of incubation. All experiments were performed in triplicate.

For agar diffusion method (zone of inhibition), 0.1 ml of *E. coli* suspension ( $\approx 10^6$  CFU/ml) or 0.25 ml of *C. acutatum* spore suspension ( $\approx 10^6$  CFU/ml) was spread with a sterile glass spreader on the surface of ECA or PDA plate (diameter 9 cm), respectively. A piece of wet sterile filter discs (6 mm diameter) with 1.0 or 2.5 mg of ClO<sub>2</sub> (crystalline form) was then deposited on the surface of the plate. Filter discs impregnated with



same amount of sterile water were used as the control. An inhibition zone assay was conducted after incubating *E. coli* at 30 °C for 24 h and *C. acutatum* at 22 °C for 3 days. Zones of inhibition (diameter) were measured to the nearest 0.1 mm by 143 Digital Caliper (General Tools Mfg. Co. LLC, New York, NY, USA).

### ***In vivo* antimicrobial activity experiments**

For *in vivo* studies with non-inoculated blueberries, 0.3 g ClO<sub>2</sub> per pad was used. A total of 27 clamshells of berries were used: 2 treatments (water control and ClO<sub>2</sub> pad) x 2 storage temperature (10 ° and 20 °C) x 2 storage times per temperature x 3 replicates + 3 clamshells for day 0. Each clamshell (replicate) contained about 180 g of berries. Berries were stored at 10 or 20 °C for 4 days and 8 days, respectively.

In order to verify our results from *in vivo* studies with non-inoculated blueberries, we conducted the second *in vivo* experiment with inoculated blueberries. For inoculum preparation, the *E. coli* and *C. acutatum* cells and spores were scraped from 4 days and 7 days old cultures on ECA and PDA media, respectively, using a sterile loop with drop of 0.1% Tween-20, to aid in even spore suspension. Cells/spores were suspended into 2 L of sterile distilled water at room temperature. The concentration of *E. coli* and *C. acutatum* was  $1.4 \times 10^9$  CFU/ml and  $1.0 \times 10^7$  CFU/ml, respectively. Fresh blueberries (about 200 g per sample) were wrapped in sterile cheese cloth and immersed in the stirred microbial suspension while stirring for 2 min. The fruit were then spread out on sterile foil and air dried for 2 h before packaging in the clamshells. Day 0 microbial assessments showed these inoculated blueberries contained 5.2 log CFU/g *E. coli* or 3.9 log CFU/g *C. acutatum*.

In the *in vivo* experiment with inoculated blueberries, 0.35 g ClO<sub>2</sub> per pad was used. A total of 65 clamshells of berries were used: 2 treatments (water control and ClO<sub>2</sub> pad) x 3 storage times x 2 microorganisms (*E. coli* and *C. acutatum*) x 5 replicates + 5 clamshells for day 0. Each clamshell (replicate) contained about 200 g of berries. The berries inoculated with *E. coli* or *C. acutatum* were packaged in the one-pound perforated clamshells and fruit were stored at 10 °C for 9 days, after which enough control fruit has been discarded that we concluded the experiment. All treatments contained three replicates.

### **Microbial enumeration**

Under sterile conditions, 20 fruit samples from each replicate (clamshell) were agitated for 1 h in 99 ml of 0.01 M sterile phosphate buffer (pH 7.2) in a sampling bag (Fisherbrand, Fisher Scientific, Pittsburgh, PA) on an orbital shaker (Innova 2100, New Brunswick Scientific, New Brunswick, NJ). For non-inoculated blueberries, serial dilutions of fruit buffer wash were spread on PCA, for enumerating TBC (total bacteria count) and PDA, for YMC (yeast/mold count) using an Eddy Jet Spiral Plater (Neutec Group Inc., Farmingdale, New York, USA). For inoculated blueberries, serial dilutions of blueberry buffer wash were spread on ECA, for enumerating *E. coli* and PDA, for *C. acutatum* using the Eddy Jet Spiral Plater. PCA, ECA and PDA plates were incubated at 25 °C for 2 days, 30°C for 24 h and at 25 °C for 3 days, respectively and the results were read on a ProtoCOL colony counter (Synoptics, Ltd., Cambridge, UK). All tests were run in triplicate.

### **Evaluation of berry firmness during storage**

Fruit firmness was measured by a FirmTech 2 Fruit Firmness Tester (Bioworks Inc, Wamego, USA), and expressed as  $N \cdot m^{-1}$ . Twenty fruit were used per replicate.

### **Statistical analyses**

All experiments were replicated at least three times. Data were analyzed using analysis of variance (ANOVA) with SPSS version 17.0 software (Experian QAS, Boston, MA). Mean separation was determined by Duncan's multiple range test. Significance was defined at  $p < 0.05$ .

## **Results and Discussion**

### ***In vitro* antimicrobial activity of ClO<sub>2</sub>**

ClO<sub>2</sub> exhibited strong antimicrobial activity in both gas fumigation (Fig. 5-1) and direct contact in water solution (Table 5-1) against *E. coli* and *C. acutatum*. Chlorine dioxide is known to reduce microorganisms by oxidation, mainly, through the one-electron transfer mechanism, in which the compound itself is reduced to chlorite (Netramai and others 2012). The mechanisms of bacterial inactivation for ClO<sub>2</sub> include: oxidation of DNA/RNA, interruption of protein synthesis, oxidation of proteins or amino acids, and oxidative cell membrane damage (Auer 2009). It has been demonstrated that ClO<sub>2</sub> has broad antimicrobial efficiency against many pathogenic and spoilage microorganisms, such as *E. coli* O157:H7, *L. monocytogenes*, and *Salmonella* spp (Mahmoud and others 2008). The mode of action of ClO<sub>2</sub> on *E. coli* was assessed and the observations of the efflux of potassium strongly implicate the loss of permeability control as the primary lethal event at the physiological level, with nonspecific oxidative

damage to the outer membrane leading to the destruction of the trans-membrane ionic gradient (Berg and others 1986). The o-nitrophenyl- $\beta$ -D-galactoside (ONPG) assay suggested that the permeability of cell wall rather than the viability of *E. coli* were changed under 0.02 mg/L ClO<sub>2</sub> treatment and the coexistence of residual ClO<sub>2</sub> and free chlorine also plays an active synergistic effect (Yang and others 2012). Both the 500 and 1,000 ppm levels of ClO<sub>2</sub> gas for 24 h treatment were successful in rendering all the conidia of hyphomycete organisms *Cladosporium cladosporioides*, *Penicillium chrysogenum*, and *Stachybotrys chartarum* completely nonculturable (Wilson and others 2005). Zhu et al. (Zhu and others 2013) reported that the minimal fungicidal ClO<sub>2</sub> concentration and treatment time for *Saccharomyces cerevisiae* were 10 mg/L and 20 min, respectively. Chen et al. reported that the treatment with 7 mg/L ClO<sub>2</sub> for 15 min reduced *Fusarium tricinctum* spores on chestnut by 4.6 log cycles, while a 5.0 log reduction in *Dothiorella gregaria* spores was detected under the same treatment condition (Chen and Zhu 2011a). These results show that ClO<sub>2</sub> can be effective to a degree as an antimicrobial agent for the inactivation of certain microorganisms.

### ***In vivo* antimicrobial activity of ClO<sub>2</sub>**

The effects of ClO<sub>2</sub> on microbial viability on the non-inoculated and inoculated blueberries were evaluated. For the non-inoculated blueberries, initial TBC and YMC was 4.2 and 4.1 log CFU/g respectively. Initial population counts of *E. coli* and *C. acutatum* of inoculated fresh blueberries was 5.2 and 3.9 log CFU/g, respectively (Fig. 5-2). Initial TBC or YMC is usually influenced by time of the year, harvest and weather

conditions, as well as the fruit wetness when picked, resulting in variability of microbial populations (Cline 1996).

In the *in vivo* experiment with non-inoculated blueberries, compared to control, the ClO<sub>2</sub> treatment reduced the TBC and YMC in the blueberries by 1.5 and 1.3 respectively after 4 days storage at 20 °C, and by 1.8 and 1.7 respectively after 8 days storage at 10 °C (Fig. 5-2). In the *in vivo* experiment with inoculated blueberries, the ClO<sub>2</sub> treatment reduced the initial populations of *E. coli* and *C. acutatum* by 4.9 and 1.6 log CFU/g respectively after 6 days storage (Fig. 5-2). The population of *E. coli* and *C. acutatum* on the blueberries was reduced by 2.2 to 3.3 and 1.3 to 2.0 log CFU/g respectively after treatment with ClO<sub>2</sub>, respectively, compared to the control (Fig. 5-2). At d 9, the effectiveness of ClO<sub>2</sub> treatment was reduced compared to d 6, perhaps due to the volatility of ClO<sub>2</sub>. These results suggest that ClO<sub>2</sub> treatment reduced microbial populations in stored blueberry fruit, depending on initial TBC or YMC, as well as storage time and temperature.

Similar results have been reported with a treatment of 15 ppm ClO<sub>2</sub> for 20 min in fresh blueberries, where the population of *Salmonella* was reduced by 3.32 log CFU/g (Wu and Kim 2007). Total aerobic bacteria and yeasts and molds in strawberries were significantly inhibited by 50 ppm of ClO<sub>2</sub> (Jin and others 2007). Chen et al. found that 60 and 80 mg/L ClO<sub>2</sub> treatments significantly reduced aerobic mesophilic bacteria, aerobic psychrotrophic bacteria, lactic acid bacteria, and yeast and mold in mulberry fruit (Chen and others 2011). At least 3-log reductions of *E. coli* O157:H7 were achieved after ClO<sub>2</sub> gas treatments on apple surfaces (Du and others 2003). Treatment with ClO<sub>2</sub> at 4.1 mg/L significantly reduced the population of *Salmonella*, *E. coli* O157:H7, and *L.*

*monocytogenes* on fresh-cut lettuce, cabbage, and carrot and *Salmonella*, yeasts, and molds on apples, peaches, tomatoes, and onions, without markedly adverse effects on sensory qualities (Sy and others 2005). It was concluded that ClO<sub>2</sub> treatment was a promising non-thermal pathogen reduction technique for fresh fruits and vegetables.

### **Firmness**

Firmness is one of the most important quality factors for blueberries (Leiva-Valenzuela and others 2013). Soft blueberries are susceptible to bruising, pressure burn and other transportation and handling injuries. Effect of ClO<sub>2</sub> treatment on fruit firmness is presented in Fig. 5-3. The firmness of ClO<sub>2</sub>-treated blueberries increased compared to the control fruit (Fig. 5-3). From both of *in vivo* experiments, the ClO<sub>2</sub> was more effective at maintaining the fruit firmness at 10 °C than 20 °C (Fig. 5-3).

Maintenance of firmness, as a result of ClO<sub>2</sub> treatment has been shown in many fruits, including strawberries (Aday and Caner 2011), lichi (Wang and others 2011), and melon (Guo and others 2013). These authors applied aqueous ClO<sub>2</sub> or ClO<sub>2</sub> gas under which ClO<sub>2</sub> was accumulated in fruit. They found that ClO<sub>2</sub> treated fruit had inhibited enzyme activity such as polyphenol oxidase and peroxidase, which attributed to a significant role in the softening process (Wang and others 2011), or inhibited respiration rate and ethylene biosynthesis (Guo and others 2013; Aday and Caner 2011), which reduced postharvest decay. A linear relationship between loss of firmness and weight loss was demonstrated in blueberries (Paniagua and others 2013). It was suggested that ClO<sub>2</sub> could reduce fruit metabolism, in addition to inhibiting weight loss and maintaining firmness (Gomez-Lopez and others 2008). In general, the changes of cell

wall polysaccharides during fruit ripening could alter the chemical structure of pectin and reduce fruit firmness (Bonnin and Lahaye 2013). Since ClO<sub>2</sub> inhibited cell wall protein synthesis, it could possibly reduce fruit softening as a result (*Mahmoud and others 2008*). Chen et al. also reported the similar results for ClO<sub>2</sub> treatment on postharvest storage quality of plum fruit (Chen and Zhu 2011b). The results in the present research suggest a similar effect of the ClO<sub>2</sub> pad resulting in maintaining fruit firmness.

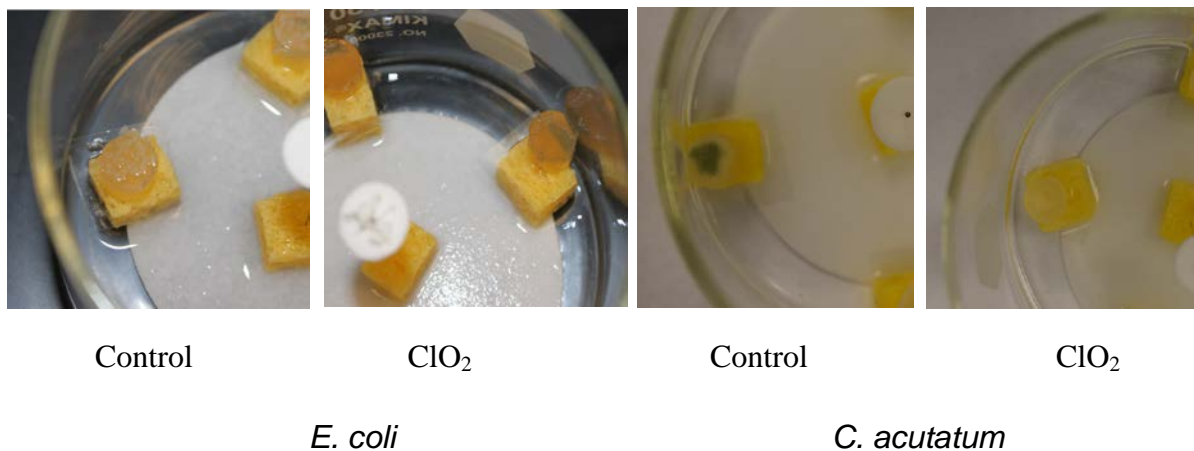
## **Conclusion**

In summary, ClO<sub>2</sub> can be used as a sanitizer for controlling foodborne pathogens as well as yeasts and molds on blueberries. The findings in this study suggest that ClO<sub>2</sub> treatment in active packaging is useful in improving the microbial safety of blueberries and reducing decay during storage without impairing the firmness.

## **Acknowledgements**

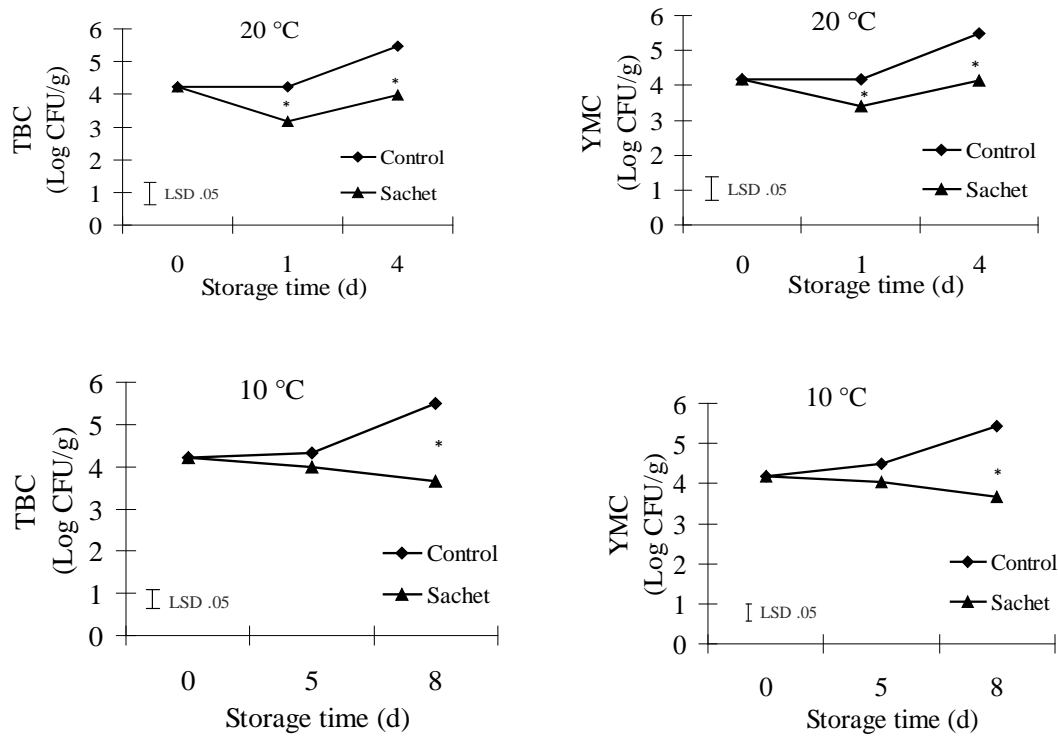
We would like to thank the financial support provided by Worrell Water Technologies. Mention of a trademark or proprietary product is for identification only and does not imply a guarantee or warranty of the product by the U.S. Department of Agriculture.

Figure 5-1. *In vitro* antimicrobial activity-chamber method to test the efficiency of  $\text{ClO}_2$  against *E. coli* and *C. acutatum*.

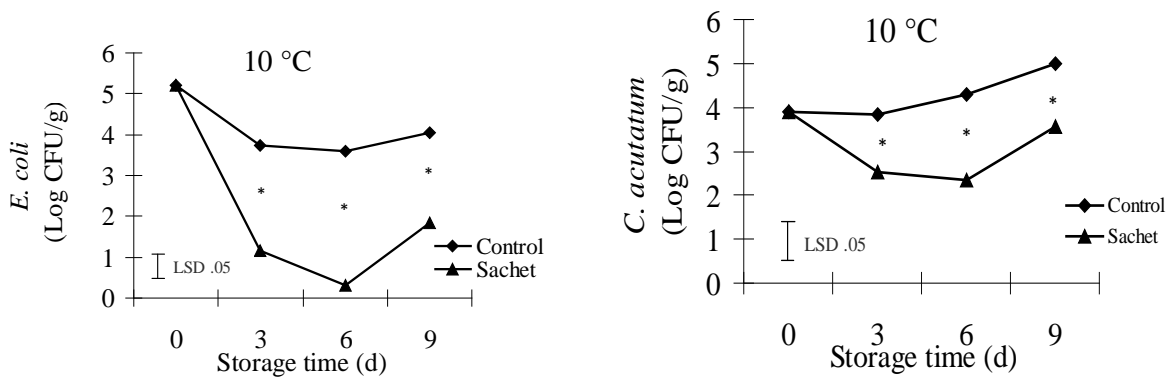




**Figure 5-2. Effects of ClO<sub>2</sub> pad on antimicrobial activities of fresh blueberries under different storage conditions, expressed in Log CFU/g. Columns within each day at same temperature marked by \*are significantly different (P>0.05) from each other.**

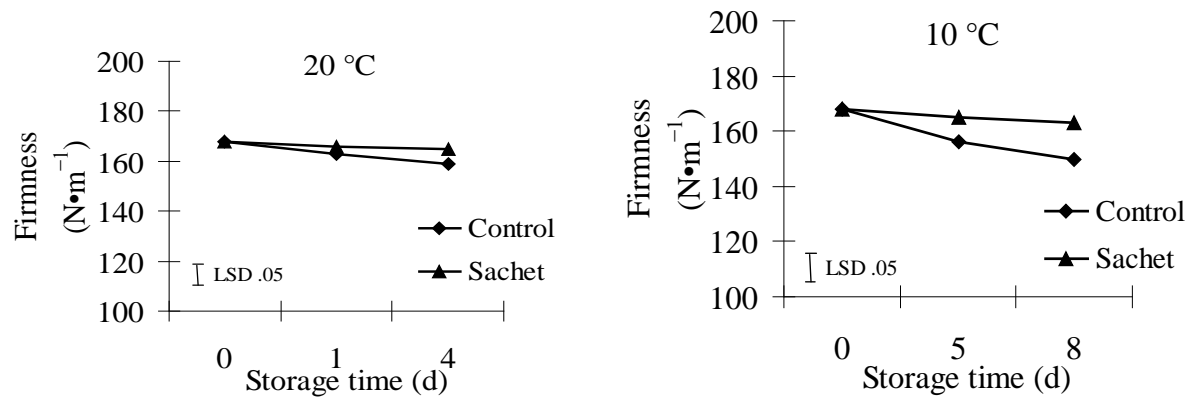


The *in vivo* experiment with non-inoculated blueberries

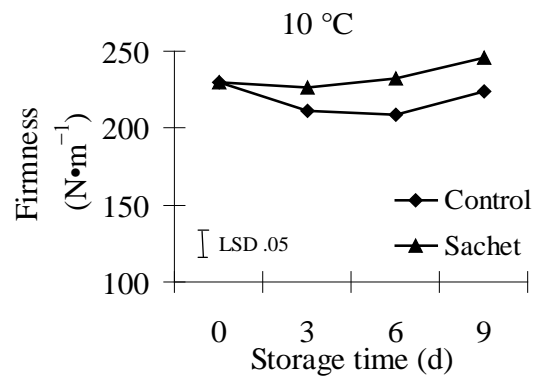


The *in vivo* experiment with inoculated blueberries

**Figure 5-3. Effects of ClO<sub>2</sub> pad on firmness of fresh blueberries under different storage conditions, expressed in N·m<sup>-1</sup>.**



The *in vivo* experiment with non-inoculated blueberries



The *in vivo* experiment with inoculated blueberries

**Table 5-1. Effect of ClO<sub>2</sub> on growth of *E. coli* and *C. acutatum*. The diameter of inhibition zone was measured and expressed in mm.**

Bacterial	ClO <sub>2</sub> (mg)	Control	Diameter (mm)
<i>E. coli</i>	2.5	0 <sup>b</sup>	38.0 ± 0.5 <sup>a</sup>
	1.0	0 <sup>b</sup>	24.0 ± 1.2 <sup>a</sup>
<i>C. acutatum</i>	2.5	0 <sup>b</sup>	39.9 ± 1.5 <sup>a</sup>
	1.0	0 <sup>b</sup>	26.9 ± 2.4 <sup>a</sup>

Superscripts in same row with different letters indicate significant differences ( $p < 0.05$ ).

## CHAPTER 6 SUNMMARY AND FUTURE DIRECTIONS

### Summary

Active packaging is packaging in which subsidiary constituents have been deliberately included in or on either the packaging material or the package headspace to enhance the performance of the package system. Active packaging emphasizes the importance of deliberately including a substance with the intention of enhancing the food product. Active packaging is an extension of the protection function of a package and is commonly used to protect against oxygen and moisture. This study demonstrated that edible films, edible coatings and sachets are a successful strategy to improve the quality of fresh fruits and vegetables and to extend their shelf-life.

The results of this study suggest that chitosan films incorporated with gallic acid improved the antimicrobial properties of the film significantly, and the films reduced microbial growth by 2.5-log reduction. Furthermore, incorporation of lower concentrations of gallic acid (0.5 g/100 g) increased the TS of the chitosan film by 71.3%. It also improved the barrier properties of chitosan film by reducing WVP and OP by 11.1% and 58.5%, respectively. Surface morphology of the film with lower gallic acid concentration revealed a homogeneous structure. Overall, chitosan films with gallic acid could be used as novel food packaging material due to their excellent antimicrobial and mechanical properties.

The present study also showed that chitosan coatings incorporated with certain essential oils (CAR, ECIN and CIN) may be an effective alternative for fresh blueberry preservation. The coatings maintained fruit firmness and reduced microbial growth on the fresh fruit during storage. CAR at  $\geq 0.1\%$  or ECIN at  $\geq 0.2\%$  incorporated with

chitosan coatings improved antimicrobial activity and all chitosan treatments decreased fruit firmness during storage. Chitosan-essential oil coatings can be used for preserving and extending the shelf life of blueberries and other perishable fruits.

$\text{ClO}_2$  can be used as a sanitizer for controlling foodborne pathogens as well as yeasts and molds on blueberries. The findings in this study suggest that  $\text{ClO}_2$  treatment in active packaging is useful in improving the microbial safety of blueberries and reducing decay during storage without impairing the firmness.

### **Future Directions**

Research areas in which future directions are recommended are summarized in the following ways.

The first recommendation for future research is to apply the chitosan-gallic acid films to the preservation of meat, fresh fruits or vegetables, such as fried chicken, fresh cucumbers, or papaya. In addition, to test the effects of the films on the quality and safety of those foods.

The second recommendation for future research is to develop new technologies and methods to reduce the effect of intense aroma of some essential oils on the coatings of fresh products. It is also recommended to use edible coatings combined with other technologies, such as gamma irradiation, modified atmospheres, and use of 1-methylcyclopropene, for inhibition of ethylene production of fresh fruits.

The third recommendation for future research is the application of chlorine dioxide sachets on the quality and safety of fresh-cut fruits. Based on the potential of antimicrobial activity of chlorine dioxide, it will be an excellent alternative packaging

material for fresh-cut fruits. Consumer acceptability and sensory evaluation need to be conducted during storage of fresh-cut fruits.

Overall, combinations of edible films, edible coatings and sachets have practical application as packaging for the food industry.

## REFERENCES

- Aday MS, Caner C. 2011. The Applications of 'Active Packaging and Chlorine Dioxide' for Extended Shelf Life of Fresh Strawberries. *Packag Technol Sci* 24(3):123-36.
- Aissani N, Coroneo V, Fattouch S, Caboni P. 2012. Inhibitory Effect of Carob (*Ceratonia siliqua*) Leaves Methanolic Extract on *Listeria monocytogenes*. *Journal of agricultural and food chemistry* 60(40):9954-8.
- Alamri A, El-Newehy MH, Al-Deyab SS. 2012. Biocidal polymers: synthesis and antimicrobial properties of benzaldehyde derivatives immobilized onto amine-terminated polyacrylonitrile. *Chem. Cent. J.* 6.
- Alejandro T-C, Francisco, L-G., Adrian, S. F. A., Francisco A-H., & Trevor, V. S. 2012. Chlorine dioxide and chlorine effectiveness to prevent *Escherichia coli* O157:H7 and *Salmonella* cross-contamination on fresh-cut Red Chard *Food Control* 23:325-32.
- Alkan D, Aydemir LY, Arcan I, Yavuzdurmaz H, Atabay HI, Ceylan C, Yemenicioglu A. 2011. Development of Flexible Antimicrobial Packaging Materials against *Campylobacter jejuni* by Incorporation of Gallic Acid into Zein-Based Films. *Journal of agricultural and food chemistry* 59(20):11003-10.
- Almenar E, Samsudin H, Auras R, Harte J. 2010. Consumer acceptance of fresh blueberries in bio-based packages. *Journal of the science of food and agriculture* 90(7):1121-8.
- Alvarez MF. 2000. Review: Active food packaging. *Food Sci Technol Int* 6(2):97-108.
- Amalaradjou MA, Baskaran SA, Ramanathan R, Johny AK, Charles AS, Valipe SR, Mattson T, Schreiber D, Juneja VK, Mancini R, Venkitanarayanan K. 2010.

- Enhancing the thermal destruction of *Escherichia coli* O157:H7 in ground beef patties by trans-cinnamaldehyde. *Food Microbiol* 27(6):841-4.
- Angeletti P, Castagnasso H, Miceli E, Terminiello L, Concellon A, Chaves A, Vicente AR. 2010. Effect of preharvest calcium applications on postharvest quality, softening and cell wall degradation of two blueberry (*Vaccinium corymbosum*) varieties. *Postharvest Biol Tec* 58(2):98-103.
- Auer JG. 2009. Use of Bioluminescent *E. coli* O157:H7 to Investigate Chlorine Dioxide Mechanism of Inactivation. [Doctor of Philosophy PhD]: Purdue University. 12 p. Available from: 3379298.
- Austin ME. 1976. Effect of Difolatan on Shelf-Life of Rabbiteye Blueberries. *Hortscience* 11(3):224.
- Ayranci E, Tunc S. 2003. A method for the measurement of the oxygen permeability and the development of edible films to reduce the rate of oxidative reactions in fresh foods. *Food Chem* 80(3):423-31.
- Bajpai SK, Chand N, Chaurasia V. 2010. Investigation of Water Vapor Permeability and Antimicrobial Property of Zinc Oxide Nanoparticles-Loaded Chitosan-Based Edible Film. *J Appl Polym Sci* 115(2):674-83.
- Bakkali F, Averbeck S, Averbeck D, Idaomar M. 2008. Biological effects of essential oils--a review. *Food Chem Toxicol* 46(2):446-75.
- Baldwin EA, Nisperoscarriedo MO, Baker RA. 1995. Edible Coatings for Lightly Processed Fruits and Vegetables. *Hortscience* 30(1):35-8.
- Berg JD, Roberts PV, Matin A. 1986. Effect of Chlorine Dioxide on Selected Membrane Functions of *Escherichia-Coli*. *J Appl Bacteriol* 60(3):213-20.



- Beuchat LR. 2002. Ecological factors influencing survival and growth of human pathogens on raw fruits and vegetables. *Microbes Infect* 4(4):413-23.
- Binutu OA, Cordell GA. 2000. Gallic Acid derivatives from mezoneuron benthamianum leaves. *Pharm Biol* 38(4):284-6.
- Bonnin E, Lahaye M. 2013. Contribution of cell wall-modifying enzymes to the texture of fleshy fruits. The example of apple. *J Serb Chem Soc* 78(3):417-27.
- Bravin B, Peressini D, Sensidoni A. 2006. Development and application of polysaccharide-lipid edible coating to extend shelf-life of dry bakery products. *J Food Eng* 76(3):280-90.
- Brody AL. 2010. Activity Today in Active Packaging. *Food Technol-Chicago* 64(3):74-6.
- Brown CA, Wang BW, Oh JH. 2008. Antimicrobial activity of lactoferrin against foodborne pathogenic bacteria incorporated into edible chitosan film. *J Food Protect* 71(2):319-24.
- Burton NC, Adhikari, A., Iossifova, Y., Grinshpun, S. A., & Reponen, T. 2013. Effect of Gaseous Chlorine Dioxide on Indoor Microbial Contaminants. *Journal of the Air & Waste Management Association*.
- Butler BL, Vergano PJ, Testin RF, Bunn JM, Wiles JL. 1996. Mechanical and barrier properties of edible chitosan films as affected by composition and storage. *Journal of food science* 61(5):953-6.
- Cagri A, Ustunol Z, Ryser ET. 2004. Antimicrobial edible films and coatings. *Journal of food protection* 67(4):833-48.

- Calder L, Simmons G, Thornley C, Taylor P, Pritchard K, Greening G, Bishop J. 2003. An outbreak of hepatitis A associated with consumption of raw blueberries. *Epidemiol Infect* 131(1):745-51.
- Camele I, Altieri L, De Martino L, De Feo V, Mancini E, Rana GL. 2012. In vitro control of post-harvest fruit rot fungi by some plant essential oil components. *Int J Mol Sci* 13(2):2290-300.
- Chanwitheesuk A, Teerawutgulrag A, Kilburn JD, Rakariyatham N. 2007. Antimicrobial gallic acid from *Caesalpinia mimosoides* Lamk. *Food Chem* 100(3):1044-8.
- Chen JR, Brody AL. 2013. Use of active packaging structures to control the microbial quality of a ready-to-eat meat product. *Food Control* 30(1):306-10.
- Chen Z, Zhu C. 2011a. Modelling inactivation by aqueous chlorine dioxide of *Dothiorella gregaria* Sacc. and *Fusarium tricinctum* (Corda) Sacc. spores inoculated on fresh chestnut kernel. *Letters in Applied Microbiology* 52(6):676-84.
- Chen Z, Zhu C, Han Z. 2011. Effects of aqueous chlorine dioxide treatment on nutritional components and shelf-life of mulberry fruit (*Morus alba* L.)(BREWING AND FOOD TECHNOLOGY). *Journal of bioscience and bioengineering* 111(6):675-81.
- Chen Z, Zhu CH. 2011b. Combined effects of aqueous chlorine dioxide and ultrasonic treatments on postharvest storage quality of plum fruit (*Prunus salicina* L.). *Postharvest Biol Tec* 61(2-3):117-23.
- Chien PJ, Sheu F, Yang FH. 2007. Effects of edible chitosan coating on quality and shelf life of sliced mango fruit. *J Food Eng* 78(1):225-9.

- Choi WS, Han JH. 2002. Film-forming mechanism and heat denaturation effects on the physical and chemical properties of pea-protein-isolate edible films. *Journal of food science* 67(4):1399-406.
- Cline WO. 1996. Postharvest infection of highbush blueberries following contact with infested surfaces. *Hortscience* 31(6):981-3.
- Coma V. 2008. Bioactive packaging technologies for extended shelf life of meat-based products. *Meat Sci* 78(1-2):90-103.
- Coma V, Martial-Gros A, Garreau S, Copinet A, Salin F, Deschamps A. 2002. Edible antimicrobial films based on chitosan matrix. *Journal of food science* 67(3):1162-9.
- Connor AM, Luby JJ, Hancock JF, Berkheimer S, Hanson EJ. 2002. Changes in fruit antioxidant activity among blueberry cultivars during cold-temperature storage. *Journal of agricultural and food chemistry* 50(4):893-8.
- Crowe KM, Bushway A, Davis-Dentici K. 2012. Impact of postharvest treatments, chlorine and ozone, coupled with low-temperature frozen storage on the antimicrobial quality of lowbush blueberries (*Vaccinium angustifolium*). *Lwt-Food Sci Technol* 47(1):213-5.
- Darmadji P, Izumimoto M. 1994. Effect of Chitosan in Meat Preservation. *Meat Sci* 38(2):243-54.
- de Abreu DAP, Cruz JM, Losada PP. 2012. Active and Intelligent Packaging for the Food Industry. *Food Rev Int* 28(2):146-87.
- Debeaufort F, Quezada-Gallo JA, Voilley A. 1998. Edible films and coatings: Tomorrow's packagings: A review. *Crit Rev Food Sci* 38(4):299-313.

- Del Campo J, Amiot MJ, Nguyen-The C. 2000. Antimicrobial effect of rosemary extracts. *Journal of food protection* 63(10):1359-68.
- Dhall RK. 2013. Advances in Edible Coatings for Fresh Fruits and Vegetables: A Review. *Crit Rev Food Sci* 53(5):435-50.
- Donhowe IG, Fennema O. 1993. The Effects of Plasticizers on Crystallinity, Permeability, and Mechanical-Properties of Methylcellulose Films. *J Food Process Pres* 17(4):247-57.
- dos Santos NS, Athayde Aguiar AJ, de Oliveira CE, Verissimo de Sales C, de Melo ESS, Sousa da Silva R, Stamford TC, de Souza EL. 2012. Efficacy of the application of a coating composed of chitosan and *Origanum vulgare* L. essential oil to control *Rhizopus stolonifer* and *Aspergillus niger* in grapes (*Vitis labrusca* L.). *Food Microbiol* 32(2):345-53.
- Du J, Han Y, Linton RH. 2003. Efficacy of chlorine dioxide gas in reducing *Escherichia coli* O157 : H7 on apple surfaces. *Food Microbiol* 20(5):583-91.
- Du J, Han, Y., & Linton, R. H. . 2003. Efficacy of chlorine dioxide gas in reducing *Escherichia coli* O157:H7 on apple surfaces. *Food Microbiology* 20:583-91.
- Du JH, Fu, M. R., Li, M. M., & Xia, W. 2007. Effects of Chlorine Dioxide Gas on Postharvest Physiology and Storage Quality of Green Bell Pepper (*Capsicum frutescens* L. var. Longrum). *Agricultural Sciences in China* 6(2):214-9.
- Duan JY, Wu RY, Strik BC, Zhao YY. 2011. Effect of edible coatings on the quality of fresh blueberries (Duke and Elliott) under commercial storage conditions. *Postharvest Biol Tec* 59(1):71-9.

- Durango AM, Soares NFF, Benevides S, Teixeira J, Carvalho M, Wobeto C, Andrade NJ. 2006. Development and evaluation of an edible antimicrobial film based on yam starch and chitosan. *Packag Technol Sci* 19(1):55-9.
- Dutta PK, Tripathi S, Mehrotra GK, Dutta J. 2009. Perspectives for chitosan based antimicrobial films in food applications. *Food Chem* 114(4):1173-82.
- Elsabee MZ, Abdou ES. 2013a. Chitosan based edible films and coatings: A review. *Mat Sci Eng C-Mater* 33(4):1819-41.
- Elsabee MZ, Abdou ES. 2013b. Chitosan based edible films and coatings: a review. *Materials science & engineering. C, Materials for biological applications* 33(4):1819-41.
- Fracassetti D, Del Bo C, Simonetti P, Gardana C, Klimis-Zacas D, Ciappellano S. 2013. Effect of Time and storage temperature on anthocyanin decay and antioxidant activity in wild blueberry ( *Vaccinium angustifolium* ) powder. *Journal of agricultural and food chemistry* 61(12):2999-3005.
- Gómez-López VM, Devlieghere, F., Ragaert, P., & Debevere, J. . 2007. Shelf-life extension of minimally processed carrots by gaseous chlorine dioxide. *International Journal of Food Microbiology* 116:221-7.
- Gómez-López VM, Ragaert, P., Jeyachandran, V., Debevere, J., & Devlieghere, F. . 2008. Shelf-life of minimally processed lettuce and cabbage treated with gaseous chlorine dioxide and cysteine. *International Journal of Food Microbiology* 121:74-83.

- Gallo LI, Pulos AMR, Jagus RJ. 2007. Effective control of *Listeria innocua* by combination of nisin, pH and low temperature in liquid cheese whey. *Food Control* 18(9):1086-92.
- Ganan M, Carrascosa AV, Martinez-Rodriguez AJ. 2009. Antimicrobial activity of chitosan against *Campylobacter* spp. and other microorganisms and its mechanism of action. *Journal of food protection* 72(8):1735-8.
- Gao P, Zhu Z, Zhang P. 2013. Effects of chitosan-glucose complex coating on postharvest quality and shelf life of table grapes. *Carbohydr Polym* 95(1):371-8.
- Gomez-Lopez VM, Ragaert P, Jeyachandran V, Debevere J, Devlieghere F. 2008. Shelf-life of minimally processed lettuce and cabbage treated with gaseous chlorine dioxide and cysteine. *Int J Food Microbiol* 121(1):74-83.
- Guo Q, Lv X, Xu F, Zhang YL, Wang JD, Lin HH, Wu B. 2013. Chlorine dioxide treatment decreases respiration and ethylene synthesis in fresh-cut 'Hami' melon fruit. *Int J Food Sci Tech* 48(9):1775-82.
- Hager AS, Vallons KJR, Arendt EK. 2012. Influence of Gallic Acid and Tannic Acid on the Mechanical and Barrier Properties of Wheat Gluten Films. *Journal of agricultural and food chemistry* 60(24):6157-63.
- Han Y, Selby, T. L., Schultzek, K. K., Nelsom, P. E., & Linton, R. H. . 2004. Decontamination of Strawberries Using Batch and Continuous Chlorine Dioxide Gas Treatment. *Journal of Food Protection* 67(11):2450-5.
- Han Y, Sherman DM, Linton RH, Nielsen SS, Nelson PE. 2000. The effects of washing and chlorine dioxide gas on survival and attachment of *Escherichia coli* O157 : H7 to green pepper surfaces. *Food Microbiol* 17(5):521-33.

- Iqbal Z, Pervez MA, Ahmad S, Iftikhar Y, Yasin M, Nawaz A, Ghazanfar MU, Dasti AA, Saleem A. 2010. Determination of Minimum Inhibitory Concentrations of Fungicides against Fungus *Fusarium Mangiferae*. Pak J Bot 42(5):3525-32.
- Jiang T, Feng L, Zheng X. 2012. Effect of chitosan coating enriched with thyme oil on postharvest quality and shelf life of shiitake mushroom (*Lentinus edodes*). Journal of agricultural and food chemistry 60(1):188-96.
- Jimenez-Bermudez S, Redondo-Nevado J, Munoz-Blanco J, Caballero JL, Lopez-Aranda JM, Valpuesta V, Pliego-Alfaro F, Quesada MA, Mercado JA. 2002. Manipulation of strawberry fruit softening by antisense expression of a pectate lyase gene. Plant Physiol 128(2):751-9.
- Jin YY, Kim YJ, Chung KS, Won M, Bin Song K. 2007. Effect of aqueous chlorine dioxide treatment on the microbial growth and qualities of strawberries during storage. Food Sci Biotechnol 16(6):1018-22.
- Johny AK, Darre MJ, Khan MI, Donoghue AM, Donoghue DJ, Venkitanarayanan K. 2010. Antibacterial activity of trans-cinnamaldehyde, eugenol, carvacrol, and thymol on *Salmonella* Enteritidis and *Campylobacter* jejuni in chicken cecal contents in vitro. J Dairy Sci 93:615-6.
- Juven BJ, Kanner J, Schved F, Weisslowicz H. 1994. Factors That Interact with the Antibacterial Action of Thyme Essential Oil and Its Active Constituents. J Appl Bacteriol 76(6):626-31.
- Kalemba D, Kunicka A. 2003. Antibacterial and antifungal properties of essential oils. Curr Med Chem 10(10):813-29.

- Khan A, Khan RA, Salmieri S, Le Tien C, Riedl B, Bouchard J, Chauve G, Tan V, Kamal MR, Lacroix M. 2012. Mechanical and barrier properties of nanocrystalline cellulose reinforced chitosan based nanocomposite films. *Carbohydr Polym* 90(4):1601-8.
- Kim H, Kim H, Bang J, Beuchat LR, Ryu JH. 2010. Synergistic Effect of Chlorine Dioxide and Drying Treatments for Inactivating *Escherichia coli* O157:H7 on Radish Seeds. *J Food Protect* 73(7):1225-30.
- Komes D, Horzic D, Belscak A, Ganic KK, Vulic I. 2010. Green tea preparation and its influence on the content of bioactive compounds. *Food Res Int* 43(1):167-76.
- Krochta JM, DeMulderJohnston C. 1997. Edible and biodegradable polymer films: Challenges and opportunities. *Food Technol-Chicago* 51(2):61-74.
- Kurek M, Moundanga S, Favier C, Galic K, Debeaufort F. 2013. Antimicrobial efficiency of carvacrol vapour related to mass partition coefficient when incorporated in chitosan based films aimed for active packaging. *Food Control* 32(1):168-75.
- Labuza TP, Breene WM. 1989. Applications of Active Packaging for Improvement of Shelf-Life and Nutritional Quality of Fresh and Extended Shelf-Life Foods. *J Food Process Pres* 13(1):1-69.
- Lee S, Lee J, Lee DY, Kim SK, Lee Y, Byun Y. 2005. A new drug carrier, Nalpha-deoxycholyl-L: -lysyl-methylester, for enhancing insulin absorption in the intestine. *Diabetologia* 48(3):405-11.
- Lee SYC, M. & Kang, D. H. 2004. Efficacy of chlorine dioxide gas as a sanitizer of lettuce leaves. *Journal of Food Protection* 67(7):1371-6.



- Leiva-Valenzuela GA, Lu RF, Aguilera JM. 2013. Prediction of firmness and soluble solids content of blueberries using hyperspectral reflectance imaging. *J Food Eng* 115(1):91-8.
- Li AJ, Chen JX, Zhu WM, Jiang T, Zhang XH, Gu QQ. 2007. Antibacterial activity of gallic acid from the flowers of *Rosa chinensis* Jacq. against fish pathogens. *Aquac Res* 38(10):1110-2.
- Li C, Luo J, MacLean D. 2011. A novel instrument to delineate varietal and harvest effects on blueberry fruit texture during storage. *Journal of the science of food and agriculture* 91(9):1653-8.
- Li Q, Zhou JP, Zhang LN. 2009. Structure and Properties of the Nanocomposite Films of Chitosan Reinforced with Cellulose Whiskers. *J Polym Sci Pol Phys* 47(11):1069-77.
- Liang J, Ludescher RD. 2011. Antioxidants Modulate Molecular Mobility, Oxygen Permeability, and Microstructure in Zein Films. *Journal of agricultural and food chemistry* 59(24):13173-80.
- Lipton K, Kantor L, Manchester A, Oliviera V. 1999. Estimating and addressing America's food losses. *Am J Agr Econ* 81(5):1325-.
- Mahmoud BSM, Bhagat AR, Linton RH. 2007. Inactivation kinetics of inoculated *Escherichia coli* O157 : H7, *Listeria monocytogenes* and *Salmonella enterica* on strawberries by chlorine dioxide gas. *Food Microbiol* 24(7-8):736-44.
- Mahmoud BSM, Bhagat, A. R., & Linton, R. H. . 2007. Inactivation kinetics of inoculated *Escherichia coli* O157:H7, *Listeria monocytogenes* and *Salmonella enterica* on strawberries by chlorine dioxide gas. *Food Microbiology* 24:736-44.

- Mahmoud BSM, Vaidya NA, Corvalan CM, Linton RH. 2008. Inactivation kinetics of inoculated *Escherichia coli* O157 : H7, *Listeria monocytogenes* and *Salmonella* Poona on whole cantaloupe by chlorine dioxide gas. *Food Microbiol* 25(7):857-65.
- Mahovic MJ, Tenney, J. D., & Bartz, J. A. . 2007. Applications of Chlorine Dioxide Gas for Control of Bacterial Soft Rot in Tomatoes. *The American Phytopathological Society* 91:1316-20.
- Mali S, Grossmann MV. 2003. Effects of yam starch films on storability and quality of fresh strawberries (*Fragaria ananassa*). *Journal of agricultural and food chemistry* 51(24):7005-11.
- Mchugh TH, Krochta JM. 1994. Milk-Protein-Based Edible Films and Coatings. *Food Technol-Chicago* 48(1):97-103.
- Mehyar GR, Han JH. 2004. Physical and mechanical properties of highamylose rice and pea starch films as affected by relative humidity and plasticizer. *Journal of food science* 69(9):E449-E54.
- Miller BD, Rigdon CE, Robinson TJ, Hedberg C, Smith KE. 2013. Use of global trade item numbers in the investigation of a salmonella newport outbreak associated with blueberries in Minnesota, 2010. *Journal of food protection* 76(5):762-9.
- Miller WR, Mitcham EJ, Mcdonald RE, King JR. 1994. Postharvest Storage Quality of Gamma-Irradiated Climax Rabbiteye Blueberries. *Hortscience* 29(2):98-101.
- Morcia C, Malnati M, Terzi V. 2012. In vitro antifungal activity of terpinen-4-ol, eugenol, carvone, 1,8-cineole (eucalyptol) and thymol against mycotoxigenic plant pathogens. *Food Addit Contam A* 29(3):415-22.

- Moreira MD, Pereda M, Marcovich NE, Roura SI. 2011. Antimicrobial Effectiveness of Bioactive Packaging Materials from Edible Chitosan and Casein Polymers: Assessment on Carrot, Cheese, and Salami. *Journal of food science* 76(1):M54-M63.
- Morino H, Matsubara A, Fukuda T, Shibata T. 2007. Inhibition of hyphal growth of the fungus *Alternaria alternata* by chlorine dioxide gas at very low concentrations. *Yakugaku Zasshi* 127(4):773-7.
- Murillo-Martinez MM, Pedroza-Islas R, Lobato-Calleros C, Martinez-Ferez A, Vernon-Carter EJ. 2011. Designing W-1/O/W-2 double emulsions stabilized by protein-polysaccharide complexes for producing edible films: Rheological, mechanical and water vapour properties. *Food Hydrocolloid* 25(4):577-85.
- Muzzarelli RAA. 1996. Chitosan-based dietary foods. *Carbohydr Polym* 29(4):309-16.
- Narciso JA. 2009. A simple method for screening antimicrobial compounds with application to plant disease and fruit quality. *Letters in applied microbiology* 48(5):548-53.
- Narciso JA, Ference CM, Ritenour MA, Widmer WW. 2012. Effect of copper hydroxide sprays for citrus canker control on wild-type *Escherichia coli*. *Letters in applied microbiology* 54(2):108-11.
- Netramai S, Rubino M, Auras R. 2012. Compatibility of Chlorine Dioxide as Antimicrobial Gas for Food Packaging Application. *Ital J Food Sci* 24(4):59-62.
- Olivas GI, Barbosa-Canovas GV. 2005. Edible coatings for fresh-cut fruits. *Crit Rev Food Sci* 45(7-8):657-70.

- Ortiz J, Marin-Arroyo MR, Noriega-Dominguez MJ, Navarro M, Arozarena I. 2013. Color, Phenolics, and Antioxidant Activity of Blackberry (*Rubus glaucus* Benth.), Blueberry (*Vaccinium floribundum* Kunth.), and Apple Wines from Ecuador. *Journal of food science* 78(7):C985-C93.
- Ozdemir M, Floros JD. 2008. Optimization of edible whey protein films containing preservatives for water vapor permeability, water solubility and sensory characteristics. *J Food Eng* 86(2):215-24.
- Padhye NV, & Doyle, M. P. 1991. Rapid procedure for detecting enterohemorrhagic *Escherichia coli* O157:H7 in food. *Applied and Environmental Microbiology* 57:2693–8.
- Paniagua AC, East AR, Hindmarsh JP, Heyes JA. 2013. Moisture loss is the major cause of firmness change during postharvest storage of blueberry. *Postharvest Biol Tec* 79:13-9.
- Park HJ, Chinnan MS. 1995. Gas and Water-Vapor Barrier Properties of Edible Films from Protein and Cellulosic Materials. *J Food Eng* 25(4):497-507.
- Park SI, Zhao YY. 2004. Incorporation of a high concentration of mineral or vitamin into chitosan-based films. *Journal of agricultural and food chemistry* 52(7):1933-9.
- Pasanphan W, Buettner GR, Chirachanchai S. 2010. Chitosan gallate as a novel potential polysaccharide antioxidant: an EPR study. *Carbohydr Res* 345(1):132-40.
- Pasanphan W, Chirachanchai S. 2008. Conjugation of gallic acid onto chitosan: An approach for green and water-based antioxidant. *Carbohydr Polym* 72(1):169-77.

- Pauli A, Knobloch K. 1987. Inhibitory effects of essential oil components on growth of food-contaminating fungi. *Zeitschrift fur Lebensmittel-Untersuchung und -Forschung* 185(1):10-3.
- Pei RS, Zhou F, Ji BP, Xu J. 2009. Evaluation of combined antibacterial effects of eugenol, cinnamaldehyde, thymol, and carvacrol against *E. coli* with an improved method. *Journal of food science* 74(7):M379-83.
- Perdones A, Sanchez-Gonzalez L, Chiralt A, Vargas M. 2012. Effect of chitosan-lemon essential oil coatings on storage-keeping quality of strawberry. *Postharvest Biol Tec* 70:32-41.
- Pereda M, Amica G, Marcovich NE. 2012. Development and characterization of edible chitosan/olive oil emulsion films. *Carbohydr Polym* 87(2):1318-25.
- Popa I, Hanson EJ, Todd EC, Schilder AC, Ryser ET. 2007. Efficacy of chlorine dioxide gas sachets for enhancing the microbiological quality and safety of blueberries. *Journal of food protection* 70(9):2084-8.
- Ramos-Garcia M, Bosquez-Molina E, Hernandez-Romano J, Zavala-Padilla G, Terres-Rojas E, Alia-Tejagal I, Barrera-Necha L, Hernandez-Lopez M, Bautista-Banos S. 2012. Use of chitosan-based edible coatings in combination with other natural compounds, to control *Rhizopus stolonifer* and *Escherichia coli* DH5 alpha in fresh tomatoes. *Crop Prot* 38:1-6.
- Ramos OL, Santos AC, Leao MV, Pereira JO, Silva SI, Fernandes JC, Franco MI, Pintado ME, Malcata FX. 2012. Antimicrobial activity of edible coatings prepared from whey protein isolate and formulated with various antimicrobial agents. *Int Dairy J* 25(2):132-41.

- Ravishankar S, Zhu LB, Olsen CW, McHugh TH, Friedman A. 2009. Edible Apple Film Wraps Containing Plant Antimicrobials Inactivate Foodborne Pathogens on Meat and Poultry Products. *Journal of food science* 74(8):M440-M5.
- Richardson SD, Plewa, M. J., Wagner, E. D., Schoeny, R., & DeMarini, D. M. . 2007. Occurrence, genotoxicity, and carcinogenicity of regulated and emerging disinfection by-products in drinking water: A review and roadmap for research. *Mutation Research* 636:178-242.
- Saidi M, Ghafourian S, Zarin-Abaadi M, Movahedi K, Sadeghifard N. 2012. In vitro antimicrobial and antioxidant activity of black thyme (*Thymbra spicata* L.) essential oils. *Roumanian archives of microbiology and immunology* 71(2):61-9.
- Samelis J, Bedie GK, Sofos JN, Belk KE, Scanga JA, Smith GC. 2002. Control of *Listeria monocytogenes* with combined antimicrobials after postprocess contamination and extended storage of frankfurters at 4 degrees C in vacuum packages. *J Food Protect* 65(2):299-307.
- Sanchez-Gonzalez L, Chafer M, Chiralt A, Gonzalez-Martinez C. 2010. Physical properties of edible chitosan films containing bergamot essential oil and their inhibitory action on *Penicillium italicum*. *Carbohydr Polym* 82(2):277-83.
- Sanchez-Gonzalez L, Pastor C, Vargas M, Chiralt A, Gonzalez-Martinez C, Chafer M. 2011. Effect of hydroxypropylmethylcellulose and chitosan coatings with and without bergamot essential oil on quality and safety of cold-stored grapes. *Postharvest Biol Tec* 60(1):57-63.

- Sanla-Ead N, Jangchud A, Chonhanchob V, Suppakul P. 2012. Antimicrobial Activity of Cinnamaldehyde and Eugenol and Their Activity after Incorporation into Cellulose-based Packaging Films. *Packag Technol Sci* 25(1):7-17.
- Schilder AC, Miles TD, Gillett JM, Jarosz AM. 2013. The effects of environmental factors on infection of blueberry fruit by *Colletotrichum acutatum*. *Phytopathology* 103(6):127-.
- Sebti I, Chollet E, Degraeve P, Noel C, Peyrol E. 2007. Water sensitivity, antimicrobial, and physicochemical analyses of edible films based on HPMC and/or chitosan. *Journal of agricultural and food chemistry* 55(3):693-9.
- Shi K, Huang YP, Yu HL, Lee TC, Huang QR. 2011. Reducing the Brittleness of Zein Films through Chemical Modification. *Journal of agricultural and food chemistry* 59(1):56-61.
- Sholberg P, Haag P, Hocking R, Bedford K. 2000. The use of vinegar vapor to reduce postharvest decay of harvested fruit. *Hortscience* 35(5):898-903.
- Shukla R, Singh P, Prakash B, Dubey NK. 2012. Antifungal, aflatoxin inhibition and antioxidant activity of *Callistemon lanceolatus* (Sm.) Sweet essential oil and its major component 1,8-cineole against fungal isolates from chickpea seeds. *Food Control* 25(1):27-33.
- Silva JL, Matta FB, Garner JO, Anderson JF. 1987. The Use of Captan to Extend Shelf-Life of Refrigerated Blueberries. *Miss Afes Res Rep* 12(16):1-3.
- Silveira AC, Conesa, A., Aguayo, E., & Artes, F. . 2008. Alternative Sanitizers to Chlorine for Use on Fresh-Cut "Galia" (*Cucumis melo* var. *catalupensis*) Melon. *Journal of Food Science* 73(9):405-11.

- Singh N, Singh, R. K., Bhunia, A. K., & Stroshine, R. L. . 2002. Efficacy of Chlorine Dioxide, Ozone, and Thyme Essential Oil or a Sequential Washing in Killing *Escherichia coli* O157:H7 on Lettuce and Baby Carrots. *LWT - Food Science and Technology* 35(8):720-9.
- Song HJ, Choi DW, Song KB. 2011. Effect of Aqueous Chlorine Dioxide and UV-C Treatment on the Microbial Reduction and Color of Cherry Tomatoes. *Hortic Environ Biote* 52(5):488-93.
- Song J, Fan LH, Forney C, Campbell-Palmer L, Fillmore S. 2010. Effect of hexanal vapor to control postharvest decay and extend shelf-life of highbush blueberry fruit during controlled atmosphere storage. *Can J Plant Sci* 90(3):359-66.
- Sothornvit R, Krochta JM. 2000. Oxygen permeability and mechanical properties of films from hydrolyzed whey protein. *Journal of agricultural and food chemistry* 48(9):3913-6.
- Sothornvit R, Krochta JM. 2001. Plasticizer effect on mechanical properties of beta-lactoglobulin films. *J Food Eng* 50(3):149-55.
- Soylu EM, Kurt S, Soylu S. 2010. In vitro and in vivo antifungal activities of the essential oils of various plants against tomato grey mould disease agent *Botrytis cinerea*. *Int J Food Microbiol* 143(3):183-9.
- Sun Y, Liu Y, Li YZ, Lv MZ, Li PW, Xu HL, Wang L. 2011. Preparation and characterization of novel curdlan/chitosan blending membranes for antibacterial applications. *Carbohydr Polym* 84(3):952-9.



- Suppakul P, Miltz J, Sonneveld K, Bigger SW. 2003. Active packaging technologies with an emphasis on antimicrobial packaging and its applications. *Journal of food science* 68(2):408-20.
- Sy KV, Murray MB, Harrison MD, Beuchat LR. 2005. Evaluation of gaseous chlorine dioxide as a sanitizer for killing *Salmonella*, *Escherichia coli* O157 : H7, *Listeria monocytogenes*, and Yeasts and molds on fresh and fresh-cut produce. *Journal of food protection* 68(6):1176-87.
- Sztuka K, Kolodziejska I. 2009. The influence of hydrophobic substances on water vapor permeability of fish gelatin films modified with transglutaminase or 1-ethyl-3-(3-dimethylaminopropyl) carbodiimide (EDC). *Food Hydrocolloid* 23(3):1062-4.
- Tao Y, Qian LH, Xie J. 2011. Effect of chitosan on membrane permeability and cell morphology of *Pseudomonas aeruginosa* and *Staphylococcus aureus*. *Carbohydr Polym* 86(2):969-74.
- Tharanathan RN. 2003. Biodegradable films and composite coatings: past, present and future. *Trends Food Sci Tech* 14(3):71-8.
- Theodoro GF, Peres NAR, Verona LAF. 2004. Outbreak of postbloom fruit drop of citrus, caused by *Colletotrichum acutatum*, in Santa Catarina State, southern Brazil. *Plant Pathology* 53(2):253-.
- Trinetta V, Morgan, M. T., & Linton, R.H. . 2010. Use of high-concentration-short-time chlorine dioxide gas treatments for the inactivation of *Salmonella enterica* spp. inoculated onto Roma tomatoes. *Food Microbiology* 27:1009-15.
- Ultee A, Kets EPW, Alberda M, Hoekstra FA, Smid EJ. 2000. Adaptation of the food-borne pathogen *Bacillus cereus* to carvacrol. *Arch Microbiol* 174(4):233-8.

- Vargas M, Albors A, Chiralt A, Gonzalez-Martinez C. 2009. Characterization of chitosan-oleic acid composite films. *Food Hydrocolloid* 23(2):536-47.
- Vermeiren L, Devlieghere F, van Beest M, de Kruijf N, Debevere J. 1999. Developments in the active packaging of foods. *Trends Food Sci Tech* 10(3):77-86.
- Vichova J, Stankova B, Pokorny R, Vejrazka K. 2013. Evaluation of Safflower Varieties for Resistance to the Fungal Pathogen, *Colletotrichum acutatum*. *Plant Protect Sci* 49(3):132-6.
- Vilela GR, de Almeida GS, D'Arce MABR, Moraes MHD, Brito JO, da Silva MFDF, Silva SC, Piedade SMD, Calori-Domingues MA, da Gloria EM. 2009. Activity of essential oil and its major compound, 1,8-cineole, from *Eucalyptus globulus* Labill., against the storage fungi *Aspergillus flavus* Link and *Aspergillus parasiticus* Speare. *J Stored Prod Res* 45(2):108-11.
- Vodnar DC. 2012. Inhibition of *Listeria monocytogenes*\_ATCC 19115 on ham steak by tea bioactive compounds incorporated into chitosan-coated plastic films. *Chem Cent J* 6.
- Wallace RJ. 2005. REPLACE: a European project on plants, their extracts and other natural alternatives to antimicrobials in animal feeds. *Euro surveillance : bulletin Europeen sur les maladies transmissibles = European communicable disease bulletin* 10(3):E050303 5.
- Wang CY, Wang SY, Chen C. 2008a. Increasing antioxidant activity and reducing decay of blueberries by essential oils. *Journal of agricultural and food chemistry* 56(10):3587-92.

- Wang CY, Wang SY, Chen C. 2008b. Increasing antioxidant activity and reducing decay of blueberries by essential oils. *Journal of agricultural and food chemistry* 56(10):3587-92.
- Wang YZ, Wu J, Ma DW, Ding JD. 2011. Preparation of a cross-linked gelatin/bacteriorhodopsin film and its photochromic properties. *Sci China Chem* 54(2):405-9.
- Wang Z, Sun XX, Lian ZX, Wang XX, Zhou J, Ma ZS. 2013. The effects of ultrasonic/microwave assisted treatment on the properties of soy protein isolate/microcrystalline wheat-bran cellulose film. *J Food Eng* 114(2):183-91.
- Wang Z, Zhou J, Wang XX, Zhang N, Sun XX, Ma ZS. 2014. The effects of ultrasonic/microwave assisted treatment on the water vapor barrier properties of soybean protein isolate-based oleic acid/stearic acid blend edible films. *Food Hydrocolloid* 35:51-8.
- Wilson SC, Wu C, Andriychuk LA, Martin JM, Brasel TL, Jumper CA, Straus DC. 2005. Effect of chlorine dioxide gas on fungi and Mycotoxins associated with sick building syndrome. *Appl Environ Microb* 71(9):5399-403.
- Wu QX, Sakabe H, Isobe S. 2003. Studies on the toughness and water resistance of zein-based polymers by modification. *Polymer* 44(14):3901-8.
- Wu VCH, Kim B. 2007. Effect of a simple chlorine dioxide method for controlling five foodborne pathogens, yeasts and molds on blueberries. *Food Microbiol* 24(7-8):794-800.
- Yadav AV, Bhise SB. 2004. Chitosan: A potential biomaterial effective against typhoid. *Curr Sci India* 87(9):1176-8.

- Yam KL, Takhistov PT, Miltz J. 2005. Intelligent packaging: Concepts and applications. *Journal of food science* 70(1):R1-R10.
- Yang W, Yang D, Zhu SY, Chen BY, Huo MX, Li JW. 2012. The synergistic effect of *Escherichia coli* inactivation by sequential disinfection with low level chlorine dioxide followed by free chlorine. *J Water Health* 10(4):557-64.
- Ye M, Neetoo H, Chen H. 2008. Control of *Listeria monocytogenes* on ham steaks by antimicrobials incorporated into chitosan-coated plastic films. *Food Microbiol* 25(2):260-8.
- Yu SH, Mi FL, Pang JC, Jiang SC, Kuo TH, Wu SJ, Shyu SS. 2011. Preparation and characterization of radical and pH-responsive chitosan-gallic acid conjugate drug carriers. *Carbohydr Polym* 84(2):794-802.
- Zheng W, Wang SY. 2003. Oxygen radical absorbing capacity of phenolics in blueberries, cranberries, chokeberries, and lingonberries. *Journal of agricultural and food chemistry* 51(2):502-9.
- Zhu CH, Chen Z, Yu GY. 2013. Fungicidal mechanism of chlorine dioxide on *Saccharomyces cerevisiae*. *Ann Microbiol* 63(2):495-502.

**ABSTRACT****DEVELOPMENT OF ACTIVE PACKAGING WITH ANTIMICROBIAL ACTIVITY**

by

**XIUXIU SUN****August 2014****Advisor:** Dr. Kequan Zhou**Major:** Nutrition and Food Science**Degree:** Doctor of Philosophy

Microbial safety of fresh fruits and vegetables is an increasing concern with any possible recall or outbreaks negatively affecting the entire industry. The interest in the development of active packaging has recently been steadily increasing due to significant concerns about environmental pollution caused by non-biodegradable packaging materials and consumer demand for high quality food products. Newly developed packaging materials and methods often have additional functional properties, such as antioxidant and antimicrobial properties.

In our study, the chitosan-gallic acid edible films and chitosan-essential oil coatings with antimicrobial activity, as well as active packaging with chlorine dioxide sachet were developed. The results show that the incorporation of gallic acid significantly increased the antimicrobial activities of the films against *Escherichia coli*, *Salmonella typhimurium*, *Listeria innocua* and *Bacillus subtilis*. Inclusion of 0.5 g/100 g gallic acid also significantly improved the mechanical and physical properties of chitosan film. For the chitosan-essential oil coatings, a combination of  $\geq 0.1\%$  CAR or  $\geq 0.2\%$  ECIN with a chitosan coating effectively reduced softening of fresh berries and

decay by inhibiting microbial growth. The effect of chlorine dioxide (ClO<sub>2</sub>) gas on the safety and quality of blueberries was also studied and the results show that ClO<sub>2</sub> treatment in active packaging improved the microbial safety of blueberries and reduced decay during storage without impairing the firmness.

## AUTOBIOGRAPHICAL STATEMENT

### Education

2014 Ph.D. of Nutrition and Food Science, Wayne State University, Detroit, MI

2008 Master Degree of Food Science, Jilin University, Changchun, China

2006 Bachelor Degree of Food Science and Engineering, Jilin University, Changchun, China

### Research Experience

2013–Visiting Scientist, U.S. Dept. of Agriculture, ARS Horticultural Research Laboratory

2012–2013 Part-time Faculty, Department of Nutrition and Food Science, Wayne State University

2011–2012 Teaching Assistant, Department of Nutrition and Food Science, Wayne State University

2008–2010 Research Technician and Teaching Assistant, Department of Food Science & Packaging Engineering, Jilin University

### Honors

2014 Summer Dissertation Fellowship, Wayne State University

2013 Rumble Fellowship, Wayne State University

2012 Graduate Professional Scholarship, Wayne State University

2010 University Graduate Research Fellowship, Wayne State University

### Publications

**Sun, X.**, Wang, Z., Kadouh, H., Zhou, K. 2014. The antimicrobial, mechanical, physical and structural properties of chitosan-gallic acid films, *LWT - Food Science and Technology* 57, 83-89.

**Sun, X.**, Narciso, J., Wang, Z., Ference, C., Bai, J., Zhou, K. Effects of chitosan-essential oil coatings on safety and quality of fresh blueberries, *Journal of Food Science* 79, M955-960.

**Sun, X.**, Bai, J., Ference, C., Wang, Z., Zhang, Y., Narciso, J., Zhou, K. The antimicrobial activity of controlled-release chlorine dioxide gas on fresh blueberries, *Journal of Food Protection* 77, 1127-1132.

Wang, Z., **Sun, X.**, Lian, Z., Wang, X., Zhou, J., Ma, Z. 2013. The effects of ultrasonic/microwave assisted treatment on the properties of soy protein isolate/microcrystalline wheat-bran cellulose film. *Journal of Food Engineering* 114, 183-191.

Wang, X., **Sun, X.**, Liu, H., Li, M., Ma, Z. 2011. Barrier and mechanical properties of carrot puree films. *Food and Bioproducts Processing* 89, 149-156.

Hogan, S., Canning, C., Sun, S., **Sun, X.**, Kadouh, H., Zhou, K. 2011. Dietary supplementation of grape skin extract improves glycemic control and inflammation in diet-induced obese mice fed a Western high fat diet. *Journal of Agricultural and Food Chemistry* 59, 3035-41.

Hogan, S., Canning, C., Sun, S., **Sun, X.**, Zhou, K. 2010. Effects of grape pomace antioxidant extract on oxidative stress and inflammation in diet induced obese mice. *Journal of Agricultural and Food Chemistry* 58, 11250-11256.

Wang, Z., Zhou, J., Wang, X., Zhang, N., **Sun, X.**, Ma, Z. 2014. The effects of ultrasonic/microwave assisted treatment on the water vapor barrier properties of soybean protein isolate-based oleic acid/stearic acid blend edible films. *Food Hydrocolloids* 35, 51-58.

Wang, Z., Zhang, N., Wang, H., Sui, S., **Sun, X.**, Ma, Z. 2014. The effects of ultrasonic/microwave assisted treatment on the properties of soy protein isolate/titanium dioxide films. *LWT - Food Science and Technology* 57, 548-555.